

**Miles
Nelson®**
Architectural
Hardware est. 1928



**Complete Range
of Door Hardware
and Accessories**

 **PROUDLY
NZ OWNED
& OPERATED**

www.milesnelson.co.nz

New Website

www.milesnelson.co.nz

Bringing up the right solutions faster!

Have a look today and let us know what you think.



Follow us on:



Founded in 1928, Miles Nelson is one of New Zealand's most trusted hardware companies and is proud to be 100% privately New Zealand owned and operated.

Based in Auckland, Miles Nelson distributes nationwide and internationally, and is well known for its quality product range, innovative design, and commitment to customer service.

Miles Nelson's long history as a manufacturer, coupled with in house technical expertise and custom designed proprietary products means that our range is specifically designed and manufactured to suit the New Zealand market.

The use of quality materials, along with a range of high-quality finishes and a suite of styles, makes the Miles Nelson range the ideal choice for commercial and residential projects.



Contents

Miles Nelson offers a comprehensive range of residential and commercial architectural hardware products:

<p>Entrance Doors</p> <ul style="list-style-type: none"> Digital & Entry Locks9 Pull Handles10 Entrance Set & Locks12 Door Viewers & Guards14 <p>Door Handles</p> <ul style="list-style-type: none"> Door Levers16 Milano on fire rated lock31 Levers & Knobs32 Mortice Locks & Rebate Kits33 Door Latches34 <p>Hinges</p> <ul style="list-style-type: none"> Hinges36 <p>Sliding Doors</p> <ul style="list-style-type: none"> Barndoor Kits40 Cavity Sliders41 Flush Pulls42 Finger Pulls44 <p>French & Double Doors</p> <ul style="list-style-type: none"> Flush Bolts46 Flush Lever Bolts47 Dust Sockets48 Socket Bolts, Necked Bolts and Cabin Hooks49 <p>Door Stops</p> <ul style="list-style-type: none"> Wall Mount Door Stops51 Floor Mount Door Stops53 Door Stops54 Latching Door Stops56 <p>Hooks</p> <ul style="list-style-type: none"> Hooks58 <p>Cabinet Hardware and Handles</p> <ul style="list-style-type: none"> Cabinet Hardware and Handles60 <p>Bannister Brackets</p> <ul style="list-style-type: none"> Lumos® Bannister Brackets62 Bannister Brackets63 	<p>Window Fittings</p> <ul style="list-style-type: none"> Window Fittings68 Window Fittings & Fasteners69 Fittings for Steel Windows69 Window Fasteners70 <p>Gate Hardware</p> <ul style="list-style-type: none"> Gate Hardware74 <p>Safety and Security</p> <ul style="list-style-type: none"> Safety and Security76 <p>Bathroom</p> <ul style="list-style-type: none"> Casa Classica Range78 Quadrato Range79 Rinnova Range80 Economy Range81 Grab Rails82 For commercial use82 Towel Rail Brackets83 Towel Rail Tubing84 Oval Rail Tubing85 Indicator bolts86 <p>Kick Plates, Numbers and Letters</p> <ul style="list-style-type: none"> Kick Plates88 House Numbers & Letters89 <p>Commercial Hardware</p> <ul style="list-style-type: none"> MNC Door Hardware Kits91 MNC5000 Series Wide Style Mortice Locks92 MNC Door Closers93 MNC Door Furniture94 <p>Warranty Information</p> <ul style="list-style-type: none"> Warranty Information96
--	---

Disclaimer: Due to continuous product development, some products may vary from those shown. The Miles Nelson guarantee/warranty, shown on the pages within, applies only when properly installed and subjected to no more than fair wear and tear. This guarantee and warranty do not extend to labour costs, personal loss, death or injury or economic, consequential or property damage of any kind whatsoever. Due to the nature of the printing process, colours may vary from those shown in this brochure. All dimensions are nominal and product should be checked prior to installation. To view our full range of products or for more information please visit milesnelson.co.nz or phone 0800 6635 766 or email info@milesnelson.co.nz

Things to Consider

Types of door functions

Entrance

Exterior doors – internal locking with turn or button, key access from outside.

Deadbolt

Single cylinder key and turn or double cylinder key locking from both sides of the door.

Passage

For general interior or hallway doors (non-locking operation).

Privacy

For bedroom or bathroom doors (internal locking, emergency access from outside).

Dummy

For wardrobe and cupboard doors (fixed lever).

Door handing

Please note that some products are handed to suit right or left hand opening doors.



RIGHT HAND
Hinges on left,
opens inward



LEFT HAND
Hinges on right,
opens inward



RIGHT HANDED HANDLE



LEFT HANDED HANDLE

Stand on the secure side of the door (where you would insert your key, or an unlocking tool if it was a privacy set). For interior doors you should stand on the side that you would enter from i.e. In the hall if opening a hall cupboard door, in the bedroom if the door opens to an ensuite, in the hall if opening into a living room.

Thickness of the door

Most interior door thicknesses range from 33-40mm. Exterior door thicknesses are between 40-45mm.

Both Milano & S-Range are suitable for door thickness: 32-45mm

If your door's thickness differs from these standards, you may need to purchase conversion components to ensure the hardware will work with your door.



Milano Drill Template

- 25mm hole plus 2x 7mm fixing holes
- 55mm Round or square rosette
- Door thickness 32-45mm
- Backset 60mm
- 25mm latch hole



S-Range Drill Template

- 54mm hole
- 65mm Round or square rosette
- Door thickness 32-45mm
- Adjustable backset 60-70mm
- 25mm latch hole

Replacing hardware

If you are looking to replace hardware on an existing door, or a door with predrilled holes, you'll need to measure the diameter of the holes and make sure that the hardware rosette will cover the openings.

Measure the backset: the distance from the door edge to the centre of the handle or key barrel and the width of the door stile: which is the vertical panel at the edge of a frame and glass panel door, where the door hardware is installed.

The width of the door stile is important when selecting a lock or handle with the correct backset, particularly if the door is paneled as this reduces the available area to install hardware.

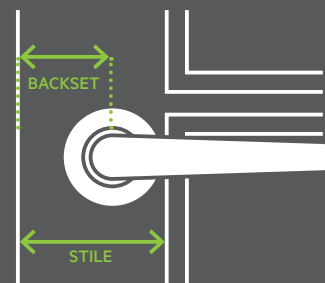

Use the Passage set drill templates to determine if your existing holes and markings will suit the Milano and/or S-Range.

Miles Nelson Common Finishes Glossary

Door hardware and window fittings are available in a variety of styles and finishes so you can choose a style that complements your home, as well as the finishes on other hardware and light fixtures.

When choosing a finish, keep in mind that oil-rubbed bronze, antique bronze and copper are all living finishes that will change over time. Polished brass can tarnish if used outside, to avoid tarnishing it is best to keep it clean and wax it lightly with an appropriate product. Another exterior option to consider is stainless steel.

There are two standard grades of stainless steel: 304 for exterior use in non-coastal areas and 316 for exterior use in properties within 500m of the ocean.

This is especially important to consider in New Zealand with our close proximity to the ocean. Stainless steel can also be cleaned using an appropriate cleaner.

For a clean, contemporary look we also offer the recently launched range of entry and internal door hardware and door stops in a matt black finish.

Please refer to the common finishes glossary below and listed with each product when making your selection.

Black Chrome	BC	Powder Coat White	PW
Brass Finish	BR	Satin Anodised	SA
Chrome Plate	CP	Satin Chrome	SC
Copper	CU	Satin Graphite	SG
Florentine Bronze	FB	Satin Nickel	SN
Gold	GD	Stainless Steel	SS
Matt Black	MB	Uncoated Raw Material	RW
Polished Stainless Steel	PS		

D-Lock

Digital Entry Lock

- Narrow style design
- Backlit touch screen / Auto locking option
- WiFi gateway available for remote access management
- Programs up to 150 codes
- IP55 weather rated
- 4 point locking compatible
- Accessible by code, Bluetooth, WiFi, fob and key

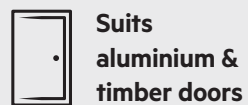

Suits aluminium & timber doors



Four-point lockbody compatible



Bluetooth

Unlock your World with your Phone



TTLock
FREE



Download on the
App Store

GET IT ON
Google Play



Entrance Doors

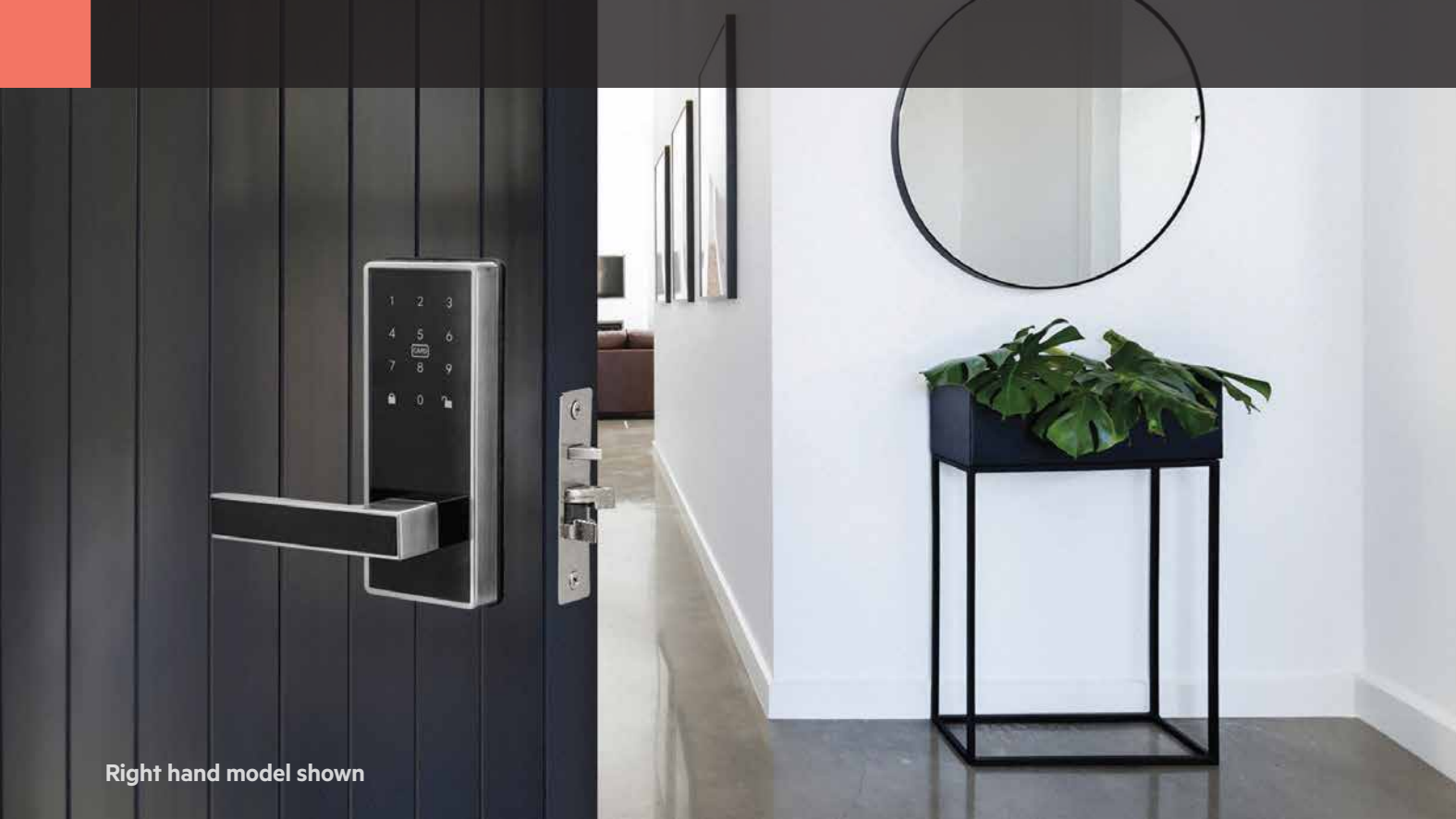

Right hand model shown

3 YEAR WARRANTY

Digital Lock

The latest electronic lock from Miles Nelson® offers unparalleled levels of security and convenience to the home owner. It is easy to programme and lets you create personal and temporary electronic keys that will allow access. It features 4 access methods - key, pin, remote or fob. Add up to 50 user codes at any one time. You can add 3 management master codes.

- Access your home by 4 way access - key, pin, remote or fob
- Palm touch - Illuminated touch pad
- High IP65 rating for water and dust ingress resistance
- Glass screen / UV protected
- Suits aluminium and timber doors 38 - 50mm thick
- Supplied with a 70mm backset that requires a minimum 110mm stile width
- 3 year warranty
- Supplied with 2 x mechanical keys, 3 x fobs, 2 x remotes, batteries included
- Unit dimensions: w 75 x h 195 x d 30mm. Handle projection 70mm

Digital Lock		Additional Accessories	
Left Hand	MN9000L	Remote	MN9000REMOTE
Right Hand	MN9000R	Fob	MN9000FOB



Illuminating touch pad



**4 way access:
Pin, fob, remote & key**



**Glass UV reflective front
provides protection against
heat, fading and sun damage**



**High IP65 rating for water and
dust ingress resistance**



Up to 50 user codes

D-Lock Digital Entry Lock

- Narrow style design
- Backlit touch screen / Auto locking option
- Four-point lockbody compatible
- WiFi gateway available for remote access management
- Programs up to 150 codes
- IP55 weather rated
- 4 point locking compatible
- Accessible by code, bluetooth, WiFi, fob, and key
- Suits aluminium and timber doors
- Suits doors 35-65mm thick
- Matt black finish (Electroplated)

2 TWO YEAR ELECTRONIC AND MECHANICAL WARRANTY



NEW

For residential

MN7030BLK	D-Lock Digital Matt Black With 30mm Backset	MB
MN7035BLK	D-Lock Digital Matt Black With 35mm Backset	MB
MN7045BLK	D-Lock Digital Matt Black With 45mm Backset	MB
MN7060BLK	D-Lock Digital Matt Black With 60mm Backset	MB
MNHUB	D-Lock Digital Wifi Hub Gateway Including Plug	MB
MN7000BLK	D-Lock Digital Handle Set Matt Black (Without Lock Body)	MB
MN7000BPBLK	D-Lock Digital Backing Cover Plate For 54mm Hole (Pair) Matt Black	MB

For commercial

MN7000BLK-2200BLK	D-Lock Digital Lock With MNC2200EP Matt Black 29mm Backset Mortice Lock	MB
MN7000BLK-2200SC	D-Lock Digital Lock With MNC2200EP Satin Chrome 29mm Backset Mortice Lock	MB
MN7000BLK-5000BLK	D-Lock Digital Lock With MNC5000ND Matt Black 60mm Backset Fire Rated Mortice Lock	MB
MN7000BLK-5000SC	D-Lock Digital Lock With MNC5000ND Satin Chrome 60mm Backset Fire Rated Mortice Lock	MB

Doorbot Digital Deadbolt

- Suitable for use with a door knob and/or pull handle
- Backlit touch screen / auto locking option
- WiFi gateway available for remote access management
- Programs up to 150 codes
- IP55 weather rated
- Accessible by code, bluetooth, WiFi, fob, and key
- Suits aluminium and timber doors
- Suits doors 35-55mm thick
- Easy 54mm hole installation
- 60 / 70mm adjustable backset
- Matt black finish (Electroplated)

Doorbot

MN8000BLK	Doorbot Digital Deadbolt Matt Black 60/70mm Adjustable Backset	MB
MN8000BLK-KIT	Doorbot Digital Entry Kit - Deadbolt With Pull Handle And Latch Turn Kit Matt Black (MN8000BLK + 781SS600BLK + 452RDPTBLK + MIL325)	MB
MNHUB	Doorbot Wifi Hub Gateway Including Plug	MB

2 TWO YEAR ELECTRONIC AND MECHANICAL WARRANTY



NEW



The Ranger 3 'n' 1 Entry Lockset

The Miles Nelson® Ranger 3'n'1 combines the latest in door hardware design that incorporates a lockset, deadbolt and passage functions all in one set.

Secure Function - Secure your home while away with the double cylinder deadlock

Safety Function - Snib the handles while at home for safety and privacy

Passage Function - Free separating passage handles for everyday convenience

- Snib locking, deadbolt and passage functions
- Made from zinc diecast
- Satin Chrome finish
- 3 x keys supplied (all keyed alike - C4 keyway)
- Tested 200,000 cycles
- Reversible handing
- 3 year warranty
- Adjustable 60/70mm backset - Separate tubular latch and bolt
- Suits 2 x 54mm fitting holes
- Overall face plate dimension 198mm (h) x 65mm (w)
- Fitting template included

698SC **SC**

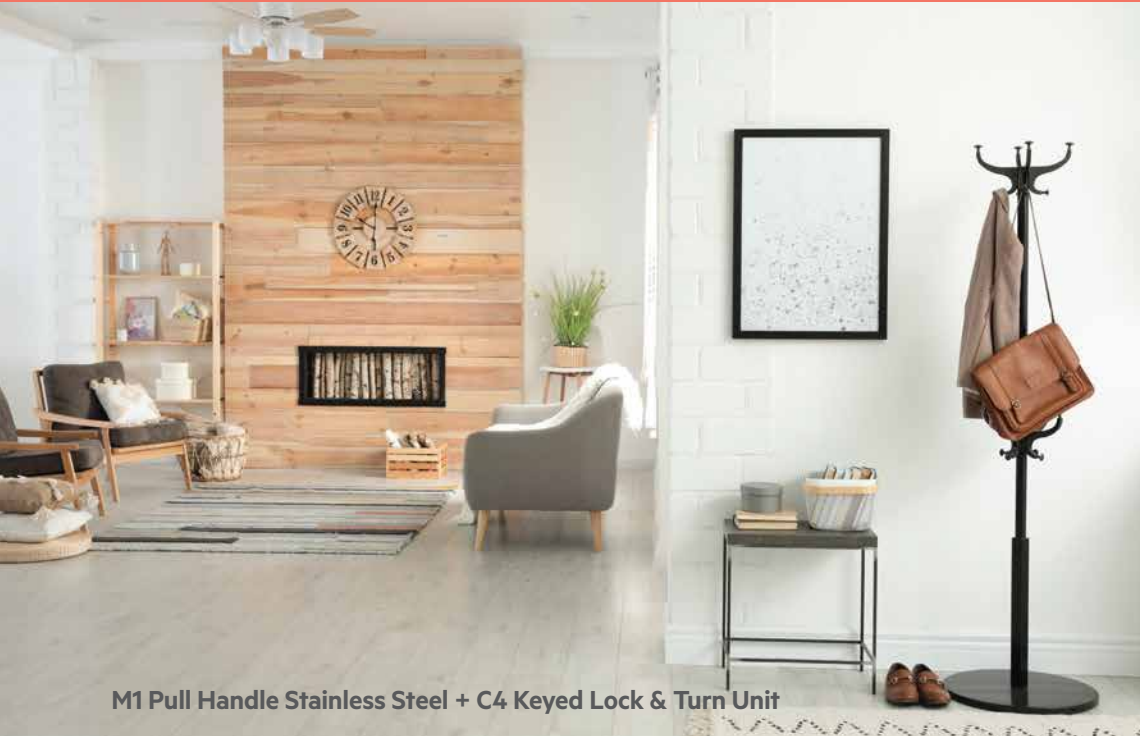

M1 Pull Handle Stainless Steel + C4 Keyed Lock & Turn Unit



M3 Square Pull Handle Stainless Steel + C4 Keyed Lock & Turn Unit

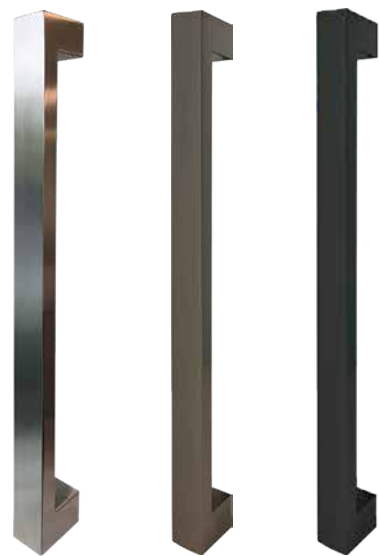

POPULAR

M1 Pull Handle

- Grip size: 40 x 20mm

Size: 300mm, centre to centre: 260mm	781SS300	SS
Size: 450mm, centre to centre: 410mm	781SS450	SS
	781SS600	SS
Size: 600mm, centre to centre: 560mm	781SG600	SG
	781SS600BLK	MB
Size: 900mm, centre to centre: 860mm	781SS900	SS
Size: 1200mm, centre to centre: 1160mm	781SS1200	SS

316 MARINE GRADE STAINLESS STEEL

DURABLE ELECTROPLATED FINISH



M2 Pull Handle



M2 Pull Handle

- Grip size: 25 x 13mm

Size: 300mm, centre to centre: 250mm	782SS300	SS
Size: 450mm, centre to centre: 400mm	782SS450	SS
Size: 600mm, centre to centre: 550mm	782SS600	SS
Size: 900mm, centre to centre: 850mm	782SS900	SS

316 MARINE GRADE STAINLESS STEEL



M3 Offset Pull Handle

- 316 marine grade stainless steel tube
- Back to back pair
- Suits door thickness: 40-52mm
- Grip size: 25 x 25mm
- Fixings supplied

Size: 600mm, centre to centre: 575mm	783SS600	SS
	783SS600BLK	MB

316 MARINE GRADE STAINLESS STEEL

POPULAR



M3 Torch Pull Handle

- 316 marine grade stainless steel tube
- Back to back pair
- Suits door thickness: 40-52mm
- Grip size: 25mm
- Fixings supplied

Size: 530mm, centre to centre: 250mm	784SS	SS
--------------------------------------	-------	----

316 MARINE GRADE STAINLESS STEEL

M3 Round Pull Handle

- 316 marine grade stainless steel tube
- Back to back pair
- Suits door thickness: 40-52mm
- Grip size: 32mm diameter
- Fixings supplied

Size: 450mm, centre to centre: 300mm	785SS450	SS
Size: 600mm, centre to centre: 450mm	785SS600	SS
Size: 600mm, centre to centre: 450mm	785SS600BLK	MB

316 MARINE GRADE STAINLESS STEEL



M3 Square Pull Handle

- 316 marine grade stainless steel tube
- Back to back pair
- Suits door thickness: 40-52mm
- Grip size: 25 x 25mm
- Fixings supplied

Size: 450mm, centre to centre: 300mm	786SS450	SS
Size: 600mm, centre to centre: 450mm	786SS600	SS

316 MARINE GRADE STAINLESS STEEL



Slimline Offset Pull Handle

- 304 stainless steel
- 420mm overall
- Grip size: 19mm diameter
- 300mm centre to centre

19mm x 300mm 9811908SS SS



Pictured: 716SNRLK60



Pull Handle Lock Kit

- Provides a secure latch which turns both sides for doors with pulls
- 60mm backset / 85mm centre from keyway to spindle
- Corrosion resistant stainless faceplate style
- Security deadbolt
- Excludes euro cylinder
- Suits up to 49mm door when used with a 70mm Euro cylinder

Square	716SNSLK60	SN
	716SGSLK60	SG
	716BLKSLK60	MB
Round	716SNRLK60	SN
	716SGRLK60	SG
	716BLKRLK60	MB
Rebate Kit	720SS	SS

Note: Face plate and strike plate supplied in stainless steel finish only.



Double Turn

- Projection 10mm
- Rose diameter 55mm
- Square 55 x 55mm
- Includes tubular latch

Round Rose	452RDPTSN	SN
Square Rose	452SDPTSN	SN

Latch Turn Kits

- Double turns and tubular latch
- Can work with pull handle and deadbolt to latch door shut
- 60mm backset

Round Rose	719RSN	SN
	719RSG	SG
	719RBLK	MB
Square Rose	719SSN	SN
	719SSG	SG
	719SBLK	MB



Euro Cylinder

- C4 profile keyway / 6 pin
- Keyed alike option
- Available in 65ml
- 3 keys supplied

Cylinder and turn 70mm	717SG70KD	SG
Cylinder and turn 70mm	717BLK70KD	MB
Cylinder and turn 70mm	717SN70KD	SN



Pictured: 719SSN



Pull Handle Square

Pull Handle Round

Copper Back to Back Pull Handles

PREMIUM

- 600mm overall length
- 400mm centre to centre
- Round – 38mm diameter
- Square – 38 x 38mm
- Grip size: 38mm
- Heavy walled copper
- Designed to age naturally
- Unlacquered finish

Square	626SBR600	CU
Round	626RBR600	CU

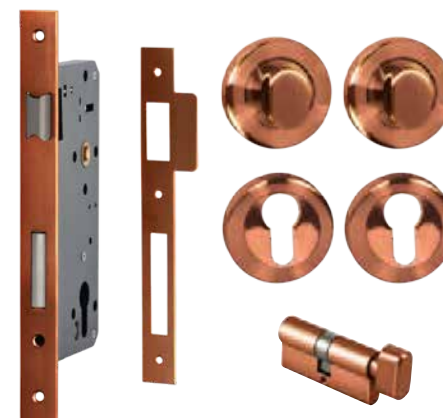

Copper Pull Handle Lock Kit

- Solid copper double turns and round escutcheons
- 85mm centre to centre mortice lock with copper face plate
- 41mm non handed copper strike
- Includes 70mm key and turn C4 euro cylinder

Round	716CURLK60	CU
Square	716CUSLK60	CU

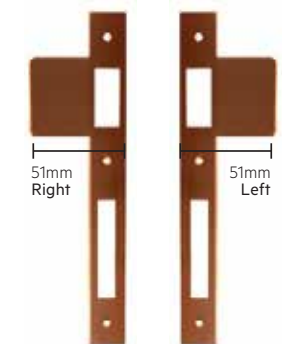

Extended Strike Plates

Left 51mm	626SPLH51	CU
Right 51mm	626SPRH51	CU
Left 61mm	626SPLH61	CU
Right 61mm	626SPRH61	CU



Safety Chain – Steel

- Designed to be strong, secure and easy to use
- DIY friendly installation
- Fixings supplied

217CP CP

5 YEAR WARRANTY



Door Guard

- Simple flip open and close operation
- Fixings supplied

707SC SC

707BR BR

5 YEAR WARRANTY



Door Viewer

- 200 degree viewing angle
- Suits door thickness: up to 60mm
- 20mm diameter
- Drill size 16mm

709SC SC

709BR BR

5 YEAR WARRANTY



Door Handles



S-Range



Sara Lever



65mm Rose
54mm hole

Ideal for
DIY
retrofit

The S-Range consists of a collection of contemporary lever designs in trendy finishes. Together with a unique interlocking system the S-Range provides a quality durable handle solution.

The base rosette is 65mm in diameter, making it an ideal handle for a retro-fit /DIY job, covering existing holes and marks. The range comes standard with a round rosette cover, however a matching square rosette is also available to purchase as an accessory.

All lever styles are available in:

- Passage Set** Includes lever set (furniture only) and tubular latch
- Integrated Privacy Set** Includes privacy lever set and privacy tubular latch
- Dummy Handle** Includes dummy lever and taylor spindle (one handle only)

- S-Range handles are non-handed and fit both left and right handed doors
- Fits 54mm existing hole sizes. Ideal for retro fits
- The Integrated Privacy Set has an auto release function that deactivates the lock by simply pushing the inside handle down.



The Matt Black and Satin Graphite finishes are electro plated, giving a durable, long lasting finish.

Square Rosette Cover

All S-Range handles are supplied with a round rosette. Square rosette covers are available separately in any of the finishes.

- Features unique locking lugs to ensure it remains square on the door.

Passage and Dummy	SCOVER	(pair)	SC
65 x 65mm	SCOVERBLK	(pair)	MB
	SCOVERSG	(pair)	SG
Privacy	SPCOVER	(pair)	SC
65 x 65mm	SPCOVERBLK	(pair)	MB
	SPCOVERSG	(pair)	SG



S-Range Satin Chrome



Shiloh Lever

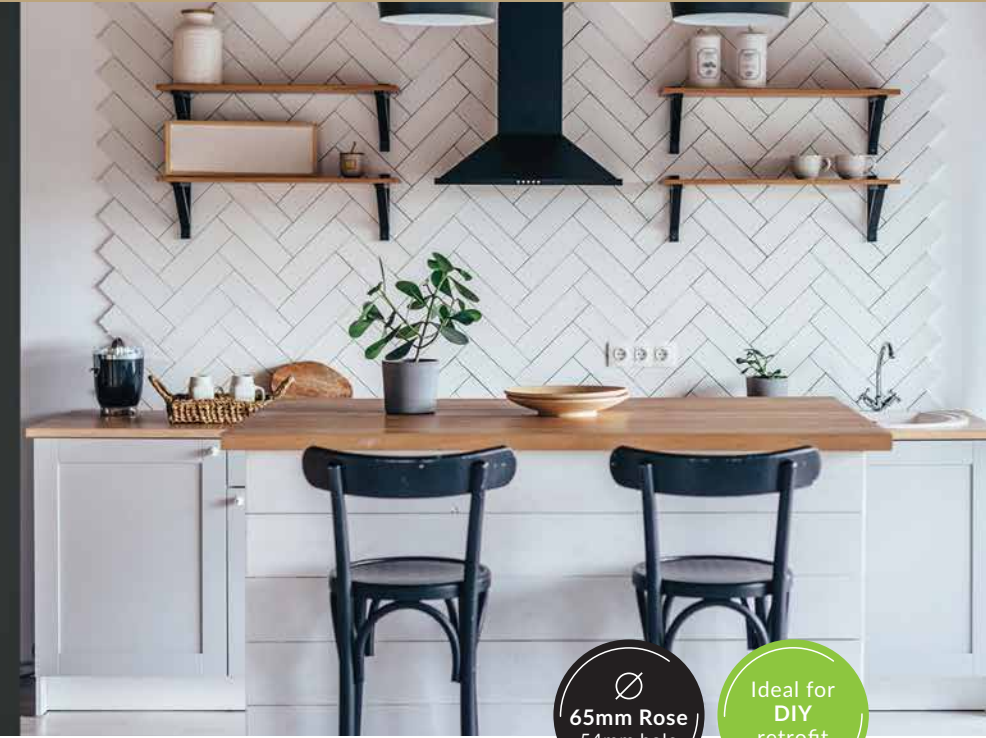

65mm Rose
54mm hole

Ideal for
DIY
retrofit

Shiloh Lever

- Satin Chrome finish only
- Handle length 120mm
- Projection 60mm
- Rose diameter 65mm

Passage	SHI101	SC
Int. Privacy	SHI102	SC
Dummy	SHI103	SC



Integrated Privacy Set



Pictured with square rosette cover (square cover sold separately)

Sara Lever

- Handle length 120mm
- Projection 60mm
- Rose diameter 65mm

Passage	SAR101	SC
Int. Privacy	SAR102	SC
Dummy	SAR103	SC



Integrated Privacy Set



Pictured with square rosette cover (square cover sold separately)

S-Range
Satin Chrome



Sienna Lever



65mm Rose
54mm hole

Ideal for
DIY
retrofit

S-Range
Satin Graphite



Sara Lever

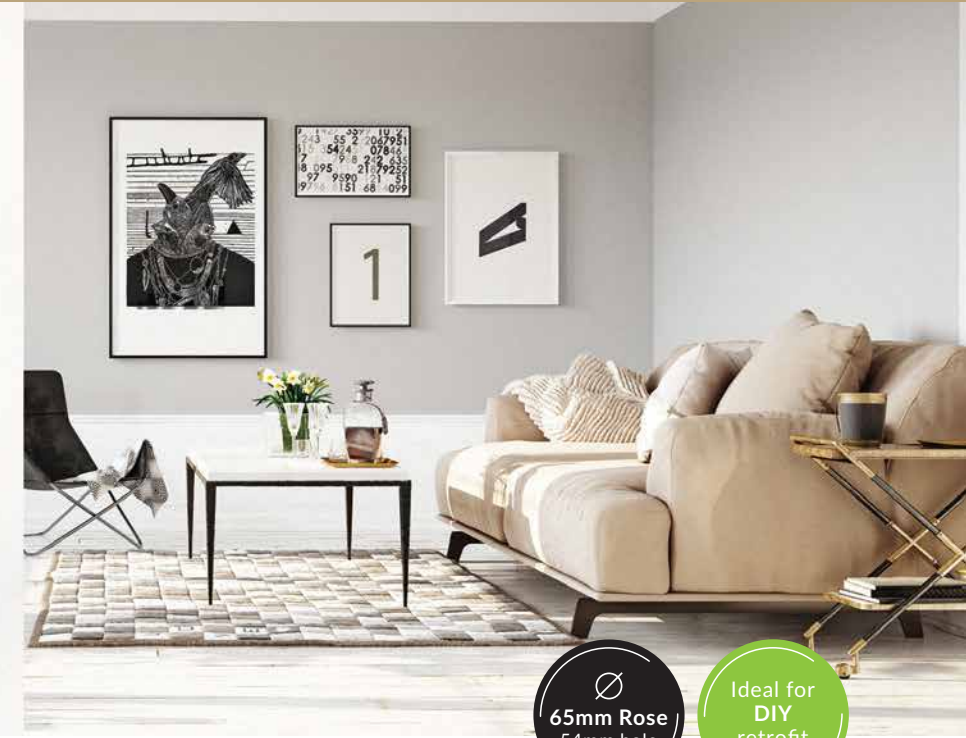

65mm Rose
54mm hole

Ideal for
DIY
retrofit



Integrated Privacy Set



Pictured with square rosette cover
(square cover sold separately)



Sienna Lever

- Satin Chrome finish only
- Handle length 120mm
- Projection 60mm
- Rose diameter 65mm

Passage	SIE101	SC
Int. Privacy	SIE102	SC
Dummy	SIE103	SC

10 YEAR MECHANICAL WARRANTY



Integrated Privacy Set



Pictured with square rosette cover
(square cover sold separately)



Skyler Lever

- Handle length 120mm
- Projection 60mm
- Rose diameter 65mm

Passage	SKY101	SC
Int. Privacy	SKY102	SC
Dummy	SKY103	SC

10 YEAR MECHANICAL WARRANTY



Sara Lever

- Handle length 120mm
- Projection 60mm
- Rose diameter 65mm

Passage	SAR101SG	SG
Int. Privacy	SAR102SG	SG
Dummy	SAR103SG	SG

10 YEAR MECHANICAL WARRANTY



Integrated Privacy Set



Pictured with square rosette cover
(square cover sold separately)

Popular matches



Round Door Stop

- Skirting mount
- Length: 85mm

202SG85A **SG**

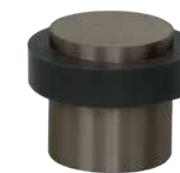

Round Door Stop

- Floor mount

Height 40mm 207SG40 **SG**

Height 60cm 207SG60 **SG**



Hinge Radius edge

- Loose pin hinge

520SGH9060R **SG**

S-Range
Matt Black



Skyler Lever



65mm Rose
54mm hole

Ideal for
DIY
retrofit



Integrated Privacy Set



Pictured with square rosette cover
(square cover sold separately)



Skyler Lever

- Handle length 120mm
- Projection 60mm
- Rose diameter 65mm

Passage	SKY101BLK	MB
Int. Privacy	SKY102BLK	MB
Dummy	SKY103BLK	MB

10 YEAR MECHANICAL WARRANTY



Integrated Privacy Set



Pictured with square rosette cover
(square cover sold separately)



Sara Lever

- Handle length 120mm
- Projection 60mm
- Rose diameter 65mm

Passage	SAR101BLK	MB
Int. Privacy	SAR102BLK	MB
Dummy	SAR103BLK	MB

10 YEAR MECHANICAL WARRANTY

Square and Round Deadbolt

- C4 keyed lock and turn
- Single cylinder only (key one side)
- Manufactured to grade 3 standard
- 65 x 65mm
- Supplied with adjustable bolt, 60 or 70mm backset
- Suits door thickness: 32-45mm
- Particularly suited for internal garage door security due to its low protrusion profile
- SC Keyed alike barrels available on request
- Fixings supplied



Square	DEAD1	SC
	DEAD1BLK	MB
	DEAD1SG	SG
Round	DEAD2	SC
	DEAD2BLK	MB
	DEAD2SG	SG

10 YEAR MECHANICAL WARRANTY

TO SUIT S RANGE HANDLES



Tubular Latch

- 8mm spindle
- 60 / 70mm adjustable latch
- Suits S Range door handles

S60/70	SC
S60/70BLK	MB
S60/70SG	SG

DURABLE ELECTROPLATED FINISH

Milano



Anzio passage set with 620SEULBOX lock

Round Deadbolt

- A deadbolt with turn + lock is ideal for internal garage doors, and is available in a matching round rosette.
- 55mm rose

Round	620SEULBOX	SN
Rosette	620SEULBOXPB	MB

10 YEAR MECHANICAL WARRANTY

TO SUIT MILANO HANDLES



Milano



Lucca Lever



55mm Rose
25mm hole

The Milano Range offers multiple designs and finishes, and is made with solid mechanical components for superior and long-lasting performance.

Milano handles offer a consistent look throughout your home from front to backdoor and every door in between.

Most handle designs are available with round or square rosette. Rosette diameter: 55mm

Door Handle Sets

Passage Set

Includes lever set and 60mm tubular latch

Privacy Set

Includes lever set, 60mm tubular latch, privacy turn set and tubular privacy bolt

Integrated Privacy Set

Includes privacy lever set and 60mm privacy tubular latch. With auto release function that deactivates the lock by simply pushing the inside handle down.

Dummy Handle

Includes dummy lever and taylor spindle (one handle only)

Entrance Set

Includes lever set, euro escutcheons, 716SS60 euro mortice lock and euro cylinder and turn

Long Plate + Lock Set

Includes euro mortice lock and cylinder and turn



Verona - VER204

Entrance Set

All Milano lever styles are available as an entrance set

- With turn + lock ideal for entrance doors
- Matching round or square rosette
- Finishes: Satin Nickel, Satin Graphite & Matt Black



INTERIOR/
EXTERIOR
USAGE



Verona - VER207

Long Plate Handles

All Milano lever styles in Satin Nickel finish are available in a long plate option in round or square edge matching the round or square rosette of the handle.

- Ideal for external doors
- Plate length W 33mm x L 240mm



INTERIOR/
EXTERIOR
USAGE

Milano

Satin Nickel



Parma Lever



55mm Rose
25mm hole

Parma Lever

- Handle length 126mm
- Projection 63mm
- Rose diameter 55mm



Round Rosette

Passage Set	PAR101	SN
Integrated Privacy Set	PAR108	SN
Privacy Set	PAR102	SN
Dummy Handle	PAR103	SN
Entrance Set	PAR104	SN
Long Plate + Lock	PAR107	SN

Square Rosette

Passage Set	PAR201	SN
Integrated Privacy Set	PAR208	SN
Privacy Set	PAR202	SN
Dummy Handle	PAR203	SN
Entrance Set	PAR204	SN
Long Plate + Lock	PAR207	SN



Verona Lever

- Handle length 125mm
- Projection 52mm
- Rose diameter 55mm

Round Rosette

Passage Set	VER101	SN
Integrated Privacy Set	VER108	SN
Privacy Set	VER102	SN
Dummy Handle	VER103	SN
Entrance Set	VER104	SN
Long Plate + Lock	VER107	SN

Square Rosette

Passage Set	VER201	SN
Integrated Privacy Set	VER208	SN
Privacy Set	VER202	SN
Dummy Handle	VER203	SN
Entrance Set	VER204	SN
Long Plate + Lock	VER207	SN



10 YEAR
MECHANICAL
WARRANTY

Forli Lever

- Handle length 126mm
- Projection 63mm
- Rose diameter 55mm

Round Rosette

Passage Set	FOR101	SN
Integrated Privacy Set	FOR108	SN
Privacy Set	FOR102	SN
Dummy Handle	FOR103	SN
Entrance Set	FOR104	SN
Long Plate + Lock	FOR107	SN

Square Rosette

Passage Set	FOR201	SN
Integrated Privacy Set	FOR208	SN
Privacy Set	FOR202	SN
Dummy Handle	FOR203	SN
Entrance Set	FOR204	SN
Long Plate + Lock	FOR207	SN



Lucca Lever

- Handle length 125mm
- Projection 63mm
- Rose diameter 55mm

Round Rosette

Passage Set	LUC101	SN
Integrated Privacy Set	LUC108	SN
Privacy Set	LUC102	SN
Dummy Handle	LUC103	SN
Entrance Set	LUC104	SN
Long Plate + Lock	LUC107	SN

Square Rosette

Passage Set	LUC201	SN
Integrated Privacy Set	LUC208	SN
Privacy Set	LUC202	SN
Dummy Handle	LUC203	SN
Entrance Set	LUC204	SN
Long Plate + Lock	LUC207	SN



Tivoli Lever

- Handle length 124mm
- Projection 61mm
- Rose diameter 55mm

Round Rosette

Passage Set	TIV101	SN
Integrated Privacy Set	TIV108	SN
Privacy Set	TIV102	SN
Dummy Handle Left	TIV103LH	SN
Dummy Handle Right	TIV103RH	SN
Entrance Set	TIV104	SN
Long Plate + Lock	TIV107	SN



POPULAR

Anzio Lever

- Handle length 128mm
- Projection 68mm
- Rose diameter 55mm

Round Rosette

Passage Set	ANZ101	SN
Integrated Privacy Set	ANZ108	SN
Privacy Set	ANZ102	SN
Dummy Handle Left	ANZ103LH	SN
Dummy Handle Right	ANZ103RH	SN
Entrance Set	ANZ104	SN
Long Plate + Lock	ANZ107	SN



Milano
Satin Graphite

Verona Entrance Set



55mm Rose
25mm hole

Verona Lever

- Handle length 125mm
- Projection 52mm
- Rose diameter 55mm

POPULAR

Round Rosette

Passage Set	VER101SG	SG
Integrated Privacy Set	VER108SG	SG
Privacy Set	VER102SG	SG
Dummy Handle	VER103SG	SG
Entrance Set	VER104SG	SG

Square Rosette

Passage Set	VER201SG	SG
Integrated Privacy Set	VER208SG	SG
Privacy Set	VER202SG	SG
Dummy Handle	VER203SG	SG
Entrance Set	VER204SG	SG

DURABLE ELECTROPLATED FINISH

10 YEAR MECHANICAL WARRANTY



Integrated Privacy Set

Privacy Set

Popular matches

Round Door Stop

- Skirting mount
- Length: 85mm

202SG85A **SG**

Round Door Stop

- Floor mount

Height 40mm 207SG40 **SG**
Height 60cm 207SG60 **SG**

Hinge Radius edge

- Loose pin hinge

520SGH9060R **SG**

Milano

Satin Graphite



Tivoli Lever

55mm Rose
25mm hole

Milano

Matt Black



Verona Lever

55mm Rose
25mm hole

Tivoli Lever

- Handle length 124mm
- Projection 61mm
- Rose diameter 55mm

Passage Set	TIV101SG	SG
Integrated Privacy Set	TIV108SG	SG
Privacy Set	TIV102SG	SG
Dummy Handle Left	TIV103SGLH	SG
Dummy Handle Right	TIV103SGRH	SG
Entrance Set	TIV104SG	SG



Parma Lever

- Handle length 126mm
- Projection 63mm
- Rose diameter 55mm

Passage Set	PAR101SG	SG
Integrated Privacy Set	PAR108SG	SG
Privacy Set	PAR102SG	SG
Dummy Handle	PAR103SG	SG
Entrance Set	PAR104SG	SG



DURABLE ELECTROPLATED FINISH

10 YEAR MECHANICAL WARRANTY

Verona Lever

POPULAR

- Handle length 125mm
- Projection 52mm
- Rose diameter 55mm

Round Rosette

Passage Set	VER101BLK	MB
Integrated Privacy Set	VER108BLK	MB
Privacy Set	VER102BLK	MB
Dummy Handle	VER103BLK	MB
Entrance Set	VER104BLK	MB

Square Rosette

Passage Set	VER201BLK	MB
Integrated Privacy Set	VER208BLK	MB
Privacy Set	VER202BLK	MB
Dummy Handle	VER203BLK	MB
Entrance Set	VER204BLK	MB



DURABLE ELECTROPLATED FINISH

10 YEAR MECHANICAL WARRANTY

Popular matches



Square Door Stop

- Skirting mount
- Length: 75mm

806PB MB



Square Door Stop

- Floor mount
- Size: 40mm

809PB MB



Hinge Radius edge

520PBH9060 MB

Milano

Matt Black



Parma Lever

55mm Rose
25mm hole

Milano

Black Chrome



Parma Lever

LUXURY FINISH

55mm Rose
25mm hole



Parma Lever

- Handle length 126mm
- Projection 63mm
- Rose diameter 55mm

Passage Set	PAR101BLK	MB
Integrated Privacy Set	PAR108BLK	MB
Privacy Set	PAR102BLK	MB
Dummy Handle	PAR103BLK	MB
Entrance Set	PAR104BLK	MB

DURABLE ELECTROPLATED FINISH

10 YEAR MECHANICAL WARRANTY



Integrated Privacy Set



Privacy Set



Parma Lever



Tivoli - Round Rosette

Passage Set	TIV101MBC	BC
Integrated Privacy Set	TIV108MBC	BC
Dummy Handle Left	TIV103MBCLH	BC
Dummy Handle Right	TIV103MBCRH	BC

10 YEAR MECHANICAL WARRANTY



Flushpull Handle

Front: 160 x 45mm
Back: 140 x 30 x 13mm

739MBC

BC



Parma - Round Rosette

Passage Set	PAR101MBC	BC
Integrated Privacy Set	PAR108MBC	BC
Dummy Handle	PAR103MBC	BC

10 YEAR MECHANICAL WARRANTY



Finger Pull

Front: 92 x 26mm
Back: 72 x 22 x 13mm

738MBC

BC

Popular matches



Round Door Stop

- Floor mount

Height 40mm 207PB MB

Height 60cm 207PB60 MB



Round Door Stop

- Skirting mount
- Length: 85mm

202DS85APBB MB

Popular matches



Door stop - floor mount

H 40mm x W 38mm 201FS40MBC BC



Door stop - wall mount

Length 85mm
Base size 32mm 202DS85MBC BC



Milano Tubular Latch

- 60mm backset
- 8mm spindle
- Includes dust box and strike plate

MIL325	SN
MIL325SG	SG
MIL325BLK	MB
MIL325MBC	BC



Taylor Spindle

- Made from Steel
- Supplied with 4 x screws
- Face fixed on door
- 8mm spindle

Length: 30mm;	777CP	CP
Base size: 33mm		

Round C4 Keyed Lock and Turn Unit

- Low profile
- Ideal for garage internal door
- Round base
- Key and turn (single cylinder)
- Base size 53mm
- Fixings supplied
- Includes bolt



6205EULBOX	SN
6205EULBOXPB	MB



Deadbolts

- 5 pin cylinder
- C4 keyway
- Suits door thickness: 32-45mm
- Supplied with adjustable bolt, 60 or 70mm backset
- Base size: 65mm
- Fixings supplied



Single cylinder: Key and turn	301DSN	SN
Double cylinder: Keyed both sides	302DSN	SN

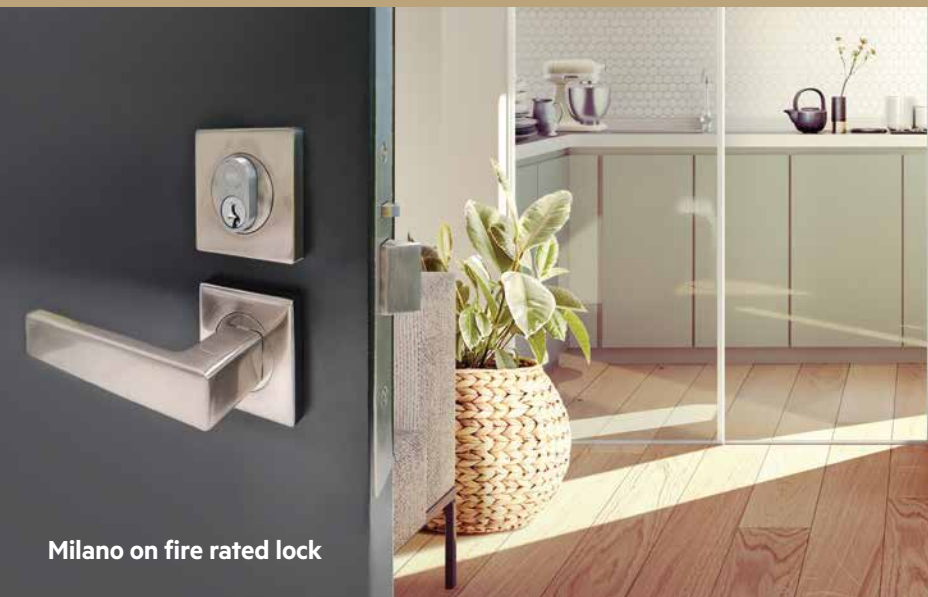

Milano on fire rated lock

Milano on fire rated lock



With a special fixing kit, all Milano styles are compatible with the MNC5000 fire rated mortice lock.

- Choose lever style – VER200 shown
- Use the 'Special fixing kit' MNCMIL2
- Fire rated mortice – MNC5000
- Also pictured – MIL406 escutcheon (as below) and MNC570 oval cylinder
- Special fixing kits also available to fit Milano privacy set or single turn snib to MNC5000



For Privacy Set

55mm privacy set with fixing kit for use MNC5000 fire rated mortice lock

MNCMIL1-RSN (Round)	SN
MNCMIL1-SSN (Square)	SN



For Lever Set

Use MNCMIL2 to adapt Milano lever sets to MNC5000 fire rated mortice lock

MNCMIL2 (Fixing kit only)



For Snib Set

55mm single turn snib for use on MNC5000 fire rated mortice lock

MNCMIL3-RSN (Round)	SN
MNCMIL3-SSN (Square)	SN

Milano Oval Escutcheon

- Projection 10mm
- Rose diameter 55mm
- Supplied in **singles**

Round Base	MIL401	SN
Square Base	MIL406	SN



Milano Euro Escutcheon

- Projection 10mm
- Rose diameter 55mm
- Supplied in **pairs**

Round Rose	MIL400	SN
	451REESG	SG
	451REEBLK	MB
Square Rose	MIL405	SN
	451SEESG	SG
	451SEEBLK	MB





Selim Latch Pass

- Made from zinc diecast
- 110mm plate size
- 7.6mm spindle
- Will suit left and right hand installation
- Sold as a pair

280CPLH	CP
280SCLH	SC



Selim Privacy Snib

- Made from zinc diecast
- 110mm plate size
- 7.6mm spindle
- Will suit left and right hand installation
- Sold as a pair

280CPS	CP
--------	----



Selim Entry Door Lock

- Made from zinc diecast
- 140mm plate size
- 7.6mm spindle
- Will suit left and right hand installation
- Sold as a pair

280CPLK	CP
---------	----



Euro Mortice Lock

- Stainless steel faceplate
- 85mm centre spindle to centre keyway

45mm Backset	716SS45	SS
60mm Backset	716SS60	SS
720SS		SS



Rebate Kit

- Stainless steel
- Suits 716SS Mortice Lock

720SS	SS
-------	----



3 Lever Mortice Locks

- 2 keys supplied
- 54mm centre spindle to top of keyway
- See bottom of page for key blanks

48mm Backset		
Case depth 64mm/	716SSN663	SN
Case height 103mm		
58mm Backset		
Case depth 77mm/	716SSN763	SN
Case height 103mm		



Pro Series Range

- Non handed
- Ergonomic design
- Concealed through door fixing
- Supplied with adjustable tubular non handed latch, 60 or 70mm backset
- To fit 54mm hole
- Suits door thickness: 32-45mm
- Base size: 65mm
- Fixings supplied

Turin Lever Set

Entrance	878SN	SN
Privacy	879SN	SN
Passage	880SN	SN
Dummy	881SN	SN



Cirque Knob Set

- 50mm brushed stainless steel alloy
- Comes with 60 and 70mm cylindrical latch

Entrance	870SS	SS
Privacy	871SS	SS
Passage	872SS	SS
Dummy	873SS	SS



Retrofit Knob Set

- Replacement knobs and spindle (non-sprung)
- Heavy duty
- 7.6mm spindle
- Furniture only set, no latch supplied
- 2 x Knobs
- Face fixed

850SN	SN
-------	----



Euro Mortice Lock/ Privacy Lock

- Mortice lock with double throw bolt
- 48mm centre to centre
- Reversible latch
- 8mm handle spindle / 5mm privacy turn spindle
- 45mm backset - 65mm (case depth)
- 60mm backset - 80mm (case depth)
- 60mm backset privacy - 80mm (case depth)

45mm Backset	453ML45SG	SG
60mm Backset	453ML60SG	SG
Privacy mortice Lock	453PMLSG	SG
Rebate kit	453RKSG	SG



Rebate Kit

- Suits 453 Euro mortice lock range

453RKSG	SG
---------	----



Rebate kit (12.5mm)

- For standard tubular latch (24.5mm hole)

291BR	BR	291FB	FB
291CP	CP	291SC	SC



5 Lever Mortice Lock

- 58mm backset
- Case depth 80mm / case height 110mm

Mortice Lock with 2 keys	716SN765	SN
5 Lever Key Blank	716KB5	
Rebate Kit for 716SN765	716SN12	SN

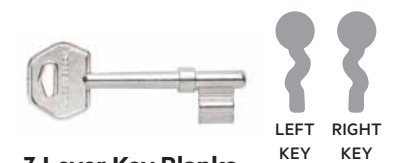

3 Lever Key Blanks

Use with 716SSN763 & 716SSN663	716KKB3L	Left	SN
Use with 716SSN763 & 716SSN663	716KKB3R	Right	SN



Tubular Latch

- 60 / 70mm adjustable latch
- 8mm spindle
- Includes dust box and strike
- Can be used for S Range lever sets

S60/70SG	SG
S60/70	SC
S60/70BLK	MB



Tubular Privacy Bolt

- 60mm backset
- 5mm spindle
- Use with MIL300 / MIL305 and 452 roses (square and round see below)

MIL320	SN
452PBSG	SG
452PBBLK	MB



Tubular Latch

- 60 or 70mm backset
- 8mm spindle
- Recessed box shield included
- Can be used for Milano lever sets

60mm Backset	MIL325	SN
	MIL325BLK	SG
	MIL325SG	MB
	MIL325MBC	BC
70mm Backset	415SN70	SN



Privacy Turn Set

- Projection 10mm
- Rose diameter 55mm
- Square 55 x 55mm
- Includes bolt

Round Rose	MIL102	SN
	MIL102SG	SG
	MIL102BLK	MB
Square Rose	MIL202	SN
	MIL202SG	SG
	MIL202BLK	MB



Double Turn Set

- Projection 10mm
- Rose diameter 55mm
- Square 55 x 55mm
- See page 20 for pull handle lock kit

Round Rose	452RDPTSN	SN
	452RDPTSG	SG
	452RDPTBLK	MB
Square Rose	452SDPTSN	SN
	452SDPTSG	SG
	452SDPTBLK	MB



Latch Turn Kits

- Double turns and includes tubular latch
- Can work with pull handle and deadbolt to latch door shut
- 60mm backset

Round Rose	719RSN	SN
	719RSG	SG
	719RBLK	MB
Square Rose	719SSN	SN
	719SSG	SG
	719SBLK	MB



Hinges



Hinge Radius Edge 90 x 60mm

- Radius edge
- Made from steel
- Loose pin
- Size: 90mmH x 60mmW x 2mmD

POPULAR

520SCH9060	(Excludes screws)	SC
520PBH9060	(Includes screws)	MB
520SNH9060	(Excludes screws)	SN
520SGH9060R	(Includes screws)	SG
520SCH9060B	(Includes screws) Supplied Bulk	SC
520SNH9060B	(Includes screws) Supplied Bulk	SN



DURABLE ELECTROPLATED FINISH

DURABLE ELECTROPLATED FINISH



316 MARINE GRADE STAINLESS STEEL

304 QUALITY STAINLESS STEEL

INTERIOR/ EXTERIOR USAGE

Hinge Square Edge 75 x 50mm Stainless Steel

- Square edge
- Made from 304 and 316 grade stainless steel
- Satin finish
- Fixed pin
- Ball bearing hinge
- Size: 75mmH x 50mmW x 2mmD
- Excludes screws

304 grade stainless steel	520SSH7550304S	SS
316 grade stainless steel	520SSH7550316S	SS

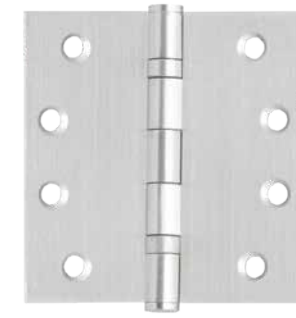

304 QUALITY STAINLESS STEEL

INTERIOR/ EXTERIOR USAGE

Hinge Square Edge 100 x 100mm Stainless Steel

- Square edge
- Made from 304 grade stainless steel
- Satin finish
- Fixed pin
- Ball bearing hinge
- Size: 100mmH x 100mmW x 2.5mmD
- Excludes screws

520SSH100100S	SS
---------------	----



Hinge Radius Edge 90 x 60mm Stainless Steel

- Radius edge
- Made from 304 grade stainless steel
- Satin finish
- Fixed pin
- Size: 90mmH x 60mmW x 2mmD
- Excludes screws

520SSH9060R	SS
-------------	----

304 QUALITY STAINLESS STEEL

INTERIOR/ EXTERIOR USAGE

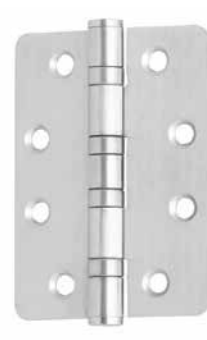

Hinge Radius Edge 100 x 75mm Stainless Steel

- Radius edge
- Made from 304 grade stainless steel
- Satin finish Fixed pin
- Ball bearing hinge
- Size: 100mmH x 75mmW x 2.5mmD
- Excludes screws

520SSH10075R	SS
--------------	----

304 QUALITY STAINLESS STEEL

INTERIOR/ EXTERIOR USAGE



Hinge Square Edge 100 x 75mm Stainless Steel

- Square edge
- Made from 304 grade stainless steel
- Satin finish
- Fixed pin
- Ball bearing hinge
- Size: 100mmH x 75mmW x 2.5mmD
- Excludes screws

520SSH10075304S	SS
-----------------	----

304 QUALITY STAINLESS STEEL

INTERIOR/ EXTERIOR USAGE



Hinge Square Edge 100 x 75mm Stainless Steel

- Square edge
- Made from 304 grade stainless steel
- Satin finish
- Fixed pin
- Ball bearing hinge
- Size: 100mmH x 75mmW x 2.5mmD
- Excludes screws

981071FFBSS	SS
-------------	----

304 QUALITY STAINLESS STEEL

INTERIOR/ EXTERIOR USAGE



Hinge Square Edge 90 x 60mm Stainless Steel

- Square edge
- Size: 90mmH x 60mmW x 2.5mmD

520SS9060	Excludes screws	SS
-----------	-----------------	----

520SGH9060	Includes screws	SG
------------	-----------------	----

304 QUALITY STAINLESS STEEL

INTERIOR/ EXTERIOR USAGE

Introducing our New Website

Find everything you need in one place

milesnelson.co.nz

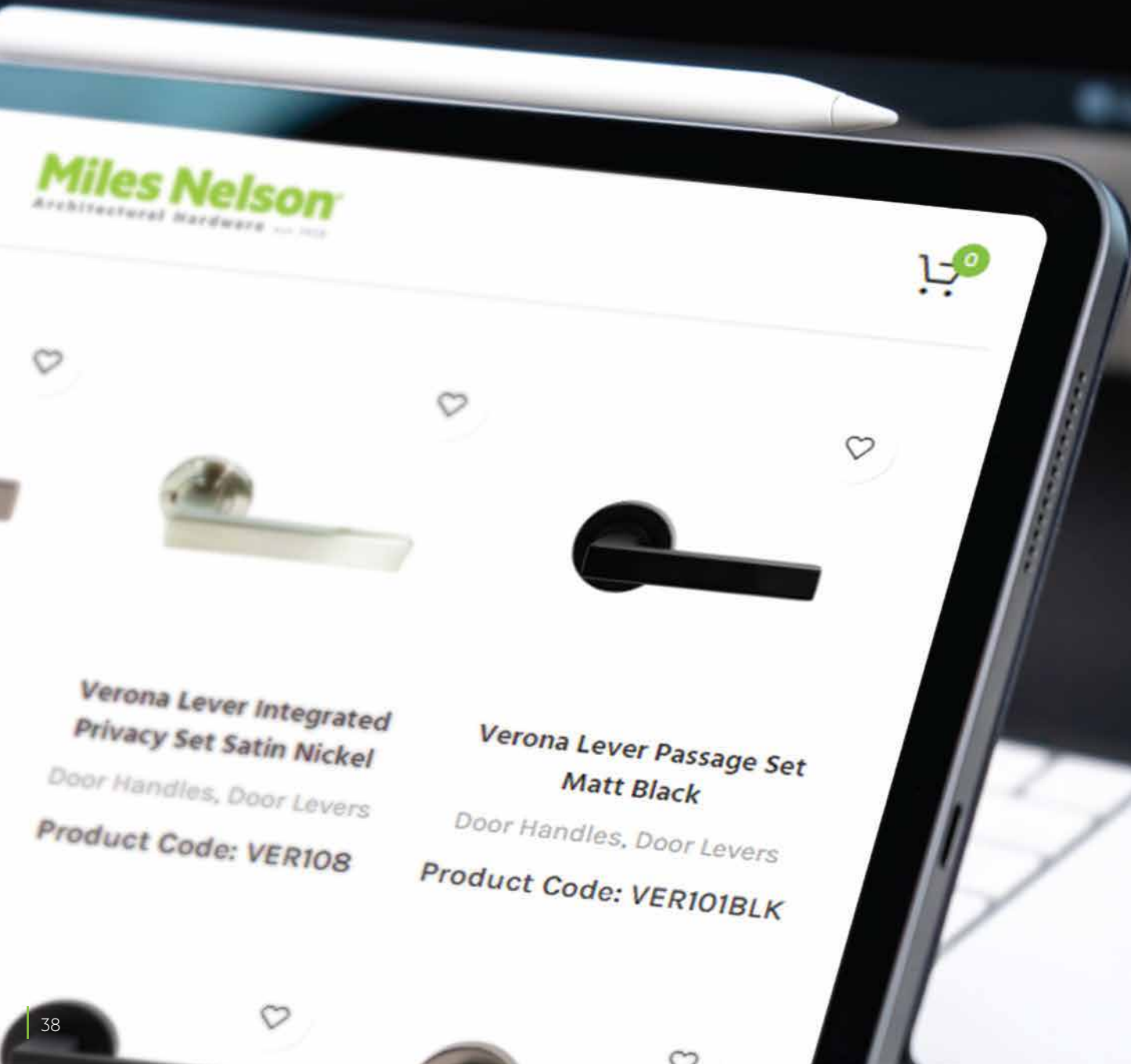

Sliding Doors



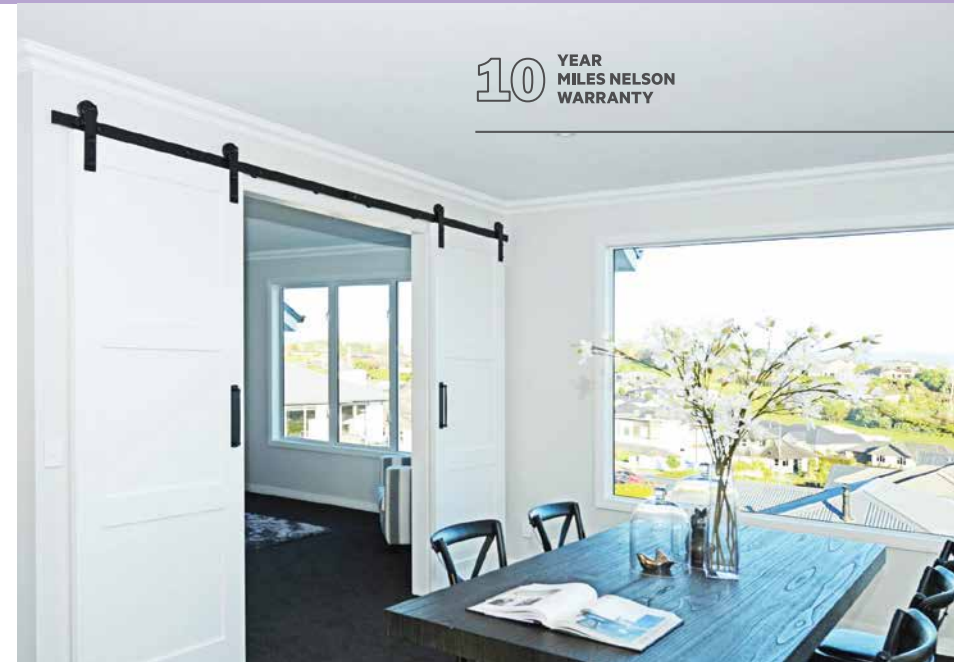

10 YEAR MILES NELSON WARRANTY



10 YEAR MECHANICAL WARRANTY



Barn Door Track Kit for Single doors

Includes 2 straight hangers straps with wheels, 1 door channel with stainless steel floor guide, adjustable soft open and close and 2 adjustable door stops



2000mm Track	BDTKS2	MB
2500mm Track	BDTKS25	MB
3000mm Track	BDTKS3	MB
3500mm Track	BDTKS35	MB
4000mm Track	BDTKS4	MB
4500mm Track	BDTKS45	MB

Barn Door Track Kit for Bi Parting doors

Includes 4 straight hangers straps with wheels, 2 door channels with stainless steel floor guides, adjustable soft open and close and 4 adjustable door stops



3000mm Track	BDTKD3	MB
3500mm Track	BDTKD35	MB
4000mm Track	BDTKD4	MB
4500mm Track	BDTKD45	MB

Wavy Barn Door Kit Back to Back Pull Handle

- 2 x pull handles
- 250mm centre to centre
- Matt black on solid stainless steel



BDK1 MB



Wavy Barn Door Kit Pull Handle + Flush Pull

- 1 x pull handle 250mm centre to centre
- 1 x flush pull, 42 x 158 x 16mm
- Matt black on solid stainless steel



BDK2 MB



Round Barn Door Kit Back to Back Pull Handle

- 2 x pull handles
- 450mm overall
- 250mm centre to centre
- Matt black on solid stainless steel



BDK3 MB



Square Barn Door Kit Back to Back Pull Handle

- 2 x pull handles
- 600mm overall
- 560mm centre to centre
- Matt black on solid stainless steel



BDK5 MB



Square Barn Door Kit Pull Handle + Flush Pull

- 1 x pull handle 560mm centre to centre
- Pull handle 600mm overall
- 1 x flush pull, 42 x 158 x 16mm
- Matt black on solid stainless steel



BDK6 MB



Round Barn Door Kit Pull Handle + Flush Pull

- 1 x pull handle 250mm centre to centre
- Pull handle 450mm overall
- 1 x flush pull, 42 x 158 x 16mm
- Matt black on solid stainless steel



BDK4 MB



Round Cavity Slider Dummy Set

- Non-locking
- Face fixing
- 54Ø x 11mm deep

538SC	SC
538SG	SG
538BLK	MB



Round Cavity Slider Passage Set

- Non-locking

537SC	SC	537SCB	SC
537SN	SN	TRADE PACK	
537SG	SG		
537BLK	MB		



POPULAR

Round Cavity Slider Privacy Set

- Locking

536SC	SC	536SCB	SC
536SN	SN	536SNB	SN
536SG	SG	TRADE PACK	
536BLK	MB		



Square Cavity Slider Dummy Set

- Non-locking

543SC	SC
543SG	SG
543BLK	MB



Square Cavity Slider Passage Set

- Non-locking

542SC	SC
542SN	SN
542SG	SG
542BLK	MB



Square Cavity Slider Privacy Set

- Locking

541SC	SC	541SCB	SC
541SN	SN	541SNB	SN
541SG	SG	TRADE PACK	
541BLK	MB		

Suitable for doors 35mm-45mm thick. 54mm fitting hole. 65mmW x 65mmH. Fixings supplied. Includes finger pull for Passage and Privacy sets.



Rectangle Privacy Flush Pull Kit for Sliding Doors

- Complete privacy sliding door solution
- Through door fixing, fixings supplied
- 35mm backset
- Suits door thickness: 35-38mm
- Door pull: 160mmH x 45mmW
- Finger pull: 26mmH x 26mmW

227SN SN

Turn knob protrudes 7mm both sides – use code 536SC for fully recessing doors

5 YEAR WARRANTY



Rectangle Edge Flush Pull Kit 100 x 50mm

- Complete cavity slider handle solution
- Concealed fixing, fixings supplied
- Includes square end finger pull (Zinc)
- Finger pull flange: 25mm (outer) x 18mm (inner)
- Door pull: 100mmH x 50mmW x 10mmD
- Kit includes 2 x door pulls and 1 x finger pull

222SS SS

222PB MB

5 YEAR WARRANTY

Rectangular Flush Pull

- Brushed stainless steel
- Two sizes available
- Concealed fixing
- Fixings supplied

Size 120mm (H) x 40mm (W) x 12mm (D)	981120SS	SS
Size 240mm (H) x 40mm (W) x 12mm (D)	9811240SS	SS

QUALITY STAINLESS STEEL



Flush Pull

- Made from aluminium
- Supplied with 2 x machine screws and 2 x wood screws
- Sold as singles
- Excl. finger pull (order separately see below)

772SC	SC
Front: Size: 42x126x16mm, Centre to centre: 96mm	772SN SN
Back: Size: 34x106x14mm	772BLK MB
772SG	SG
773SC	SC
Front: Size: 42x158x16mm, Centre to centre: 128mm	773SN SN
Back: Size: 34x138x14mm	773BLK MB
773SG	SG
Front: Size: 42x190x16mm, Centre to centre: 160mm	774SN SN
Back: Size: 34x170x14mm	774SG SG
Front: Size: 42x254x16mm, Centre to centre: 224mm	775SN SN
Back: Size: 34x235x14mm	775SG SG

All available in trade pack just add a 'B' behind the code

TRADE PACK



Square Edge Flush Pull

- Made from stainless steel SS304
- Size 102mmH x 52mmW x 10mmD
- Sold separately

Face fixed	713SS	SS
Concealed fix	733SS	SS
	733PB	MB
	733SSB	SS
	733PBB	MB

TRADE PACK

304 QUALITY STAINLESS STEEL

Flush Pull

- Available in 100 x 37mm & 140 x 33mm
- Face fix
- Fixings supplied

Size 100mm (H) x 37mm (W) x 10mm (D)	106SC100	SC
	106CP100	CP
	106FB100	FB
	106GD100	GD
	106PW100	PW
Size 140mm (H) x 33mm (W) x 10mm (D)	106SC140	SC
	106CP140	CP
	106FB140	FB

5 YEAR WARRANTY



Round Privacy Flush Pull Kit for Sliding Doors

- Flush pull: 160mmH x 40mmW
- Finger pull: 30mm
- Complete privacy sliding door solution
- Through door fixing, fixings supplied
- 35mm backset
- Suits door thickness: 35-38mm

228SS SS

Turn knob protrudes 5mm both sides – use code 536SC for fully recessing doors

QUALITY STAINLESS STEEL



Oval Round Edge Flush Pull Kit

- Flush pull: 120mmH x 40mmW x 11mmD
- Finger pull flange: 30mm (outer) x 26mm (inner) x 10mmD complete cavity slider handle solution
- Kit includes 2 x door pulls and 1 x finger pull
- Concealed fixing, fixings supplied
- Includes end finger pull (zinc)

224SS SS

224PB MB

5 YEAR WARRANTY

Oval Edge Flush Pull

- Size 120mmH x 40mmW x 10mmD
- Made from stainless steel SS304
- Sold separately

Face fixed	712SS	SS
Concealed fix	732SS	SS
	732PB	MB
	732SSB	SS
	732PBB	MB

TRADE PACK

316 MARINE GRADE STAINLESS STEEL



Square Flush Finger Pull

- Flange: 25mm (outer) x 16mm (inner) x 18mmD
- For cavity door edges and cupboard doors
- To be fixed into the same size diameter hole
- 20mm depth
- Fixed with one screw (black screw supplied)
- Can also be glue fixed

748SS26	SS
748PB26	MB
748SG26	SG



Round Flush Finger Pull

- For cavity door edges and cupboard doors
- To be fixed into the same size diameter hole
- 20mm depth
- Fixed with one screw (black screw supplied)
- Can also be glue fixed

Size 30mm	744PB30	MB
Inner circle 26mm	744SC30	SC
Size 40mm	744SC40	SC
Inner circle 35mm		
Size 50mm	744SC50	SC
Inner circle 40mm		



Round Flush Finger Pull

- To be glued into the same size diameter hole
- Concealed fixing
- 70mm cut out size

Flange 90mm		
Diameter 72mm	745SS90	SS
Depth 19mm		



Finger Pull Rectangle

- Made from stainless steel SS304
- Concealed fix

90mm x 26mm	738SS	SS
-------------	-------	----



Finger Pull with Stainless Steel Hook

- Made from stainless steel SS304
- Supplied with 2 x wood screws

100x20x22mm	776SS	SS
-------------	-------	----



POPULAR

Black standard



Standard



With cup

Door Magnet

- Size: 22 x 6mm
- Countersunk fixings supplied
- N42 magnet strength

Drill size 22mm	1 pair	332CP	CP
	1 pair	332BLK	MB
	6 pairs	332/6CP	CP
Drill size 25mm	1 pair magnet with cups	332MWC	CP

French & Double Doors





Flush Straight Bolt

- Made from solid brass, one piece extrusion
- Made from extruded brass
- Suitable for bi fold, sliding and hinged doors
- Length 100mm, bolt 8mm, throw 36mm
- Length 150mm, bolt 10mm, throw 25mm
- Positive locating
- Fixings supplied

215SC08100	SC
215BR08100	BR
215SN08100	SN
215SC10150	SC
215BR10150	BR
215SN10150	SN
215PB10150	MB



DESIGNED BY MILES NELSON



Flush Necked Bolt

- Made from solid brass, **one piece extrusion**
- Forged neck bolt for superior strength
- Suitable for bi fold, sliding and hinged doors
- Length 100mm, bolt 8mm, throw 20mm, offset 6mm
- Length 150mm, bolt 10mm, throw 25mm, offset 11mm
- Fixings supplied

216SC08100	SC
216BR08100	BR
216SN08100	SN
216SC10150	SC
216BR10150	BR
216SN10150	SN



DESIGNED BY MILES NELSON

Flush Inward Necked Bolt

- Made from solid brass, one piece extrusion
- Length 150mm, bolt 10mm, throw 25mm, offset 9mm
- Fixings supplied

218SN10150	SN
------------	----

Flush Necked Bolt

- Made from solid brass
- Length 150mm, bolt 10mm, throw 25mm, offset 8mm
- Length 200mm, bolt 10mm, throw 25mm, offset 8mm

217SN10150	SN
217SN10200	SN



Flush Lever Bolt

- Made from stainless steel
- Lever action
- Length 150mm, Bolt 12mm, Throw 18mm
- Width 19mm
- Fixings supplied

711SC	SS
711BR	PB



Flush Lever Bolt

- Made from forged solid brass
- Lever action
- Heavy duty
- Size 150mm x 25mm, Throw 18mm, Rod 12mm
- Fixings supplied

305SC150	SC
305SC150B	SC
305SG150	SG
305SN150	SN



Flush Necked Bolt 150mm



- Made from solid brass
- Available in standard non-locking or key locking function
- Length 150mm, bolt 9mm, throw 30mm
- Keyed alike available on request

Non-locking	405SC150	SC
	405SG150	SG
Locking	405SCL150	SC
	405SGL150	SG



DESIGNED BY MILES NELSON



Flush Straight Bolt 150mm



- Made from solid brass
- Available in standard non-locking or key locking function
- Length 150mm, bolt 9mm, throw 30mm
- Keyed alike available on request

Non-locking	505SC150	SC
	505SG150	SG
Locking	505SCL150	SC
	505SGL150	SG



DESIGNED BY MILES NELSON



Flat Bar Flush Lever Bolt

- Made from forged solid brass
- Lever action
- Heavy duty
- Bolt is a flat bar
- Size 150mm x 25mm, Throw 18mm
- Fixings supplied

305SC150F	SC
-----------	----



Auto Flush Bolt



- 160mm x 20mm
- Supplied as **pair** (left and right hand)
- For use on double doors
- Suitable for rebated and non-rebated doors
- 12mm Bolt
- Great for tall doors

MNC-AFB3000	SS
-------------	----



*Fire ratings only apply to selected fire doors. Check with Miles Nelson.



Dust Socket

- Made from solid brass
- For use with flush bolts, socket bolts, neck bolts and patio bolts (up to 12mm thick bolt)
- Concrete and timber fix
- Length: 47mm
Flange diameter: 43mm
Socket diameter: 21mm

	214SC	SC
For timber	214SN	SN
	314SC	SC
For concrete	314SCB	SC
	314PB	MB

Suits: 711, 215, 216 and 305 series flush bolts



Dust Socket

- Made from solid brass
- For use with flush bolts, socket bolts, neck bolts and patio bolts (up to 12mm thick bolt)
- Concrete and timber fix
- Length: 40mm
Diameter: 19mm
- Fits 12mm diameter bolts

	706SC	SC
	706BR	PB

Suits: 711, 215, 216 and 305 series flush bolts



Socket Bolts

- 8mm or 10mm rod
- Fixings supplied

8 x 35mm	262CP0835ECO	CP
	262SC0835ECO	SC
	262BR0835ECO	BR
	262FB0835ECO	FB
8 x 50mm	262CP0850ECO	CP
	262SC0850ECO	SC
	262BR0850ECO	BR
	262FB0850ECO	FB
8 x 75mm	262CP0875ECO	CP
	262SC0875ECO	SC
	262BR0875ECO	BR
	262FB0875ECO	FB
8 x 100mm	262CP08100ECO	CP
	262SC08100ECO	SC
	262BR08100ECO	BR
	262FB08100ECO	FB
8 x 150mm	262CP10150ECO	CP
	262SC10150ECO	SC
	262BR10150ECO	BR
	262FB10150ECO	FB
10 x 200mm	262SC10200ECO	SC

To order separate staple only:
262**08S; 262**10S. S=Staple.

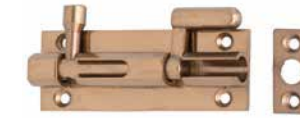

Necked Bolts

- 8mm or 10mm rod
- Fixings supplied

8 x 50mm	269CP0850ECO	CP
	269SC0850ECO	SC
8 x 75mm	269CP0875ECO	CP
	269SC0875ECO	SC
8 x 100mm	269BR0875ECO	BR
	269FB0875ECO	FB
8 x 100mm	269CP08100ECO	CP
	269SC08100ECO	SC
	269BR08100ECO	BR
	269FB08100ECO	FB
8 x 100mm	269SG08100ECO	SG
	269CP10150ECO	CP
	269SC10150ECO	SC
	269BR10150ECO	BR
8 x 100mm	269FB10150ECO	FB
	269SG10150ECO	SG

To order separate flat plate only:
272**08 (8mm); 272**10 (10mm)



Cabin Hooks - Commercial

- Super heavy duty

150mm	376SS150	SS
200mm	376SS200	SS



Cabin Hooks

- 8mm or 10mm rod
- Fixings supplied
- Forged bras

50mm	276BR0850BP	BR
	276CP0850BP	CP
	276FB0850BP	FB
50mm	276SC0850BP	SC
	276BR0875BP	BR
	276CP0875BP	CP
75mm	276FB0875BP	FB
	276SC0875BP	SC
	276SG0875	SG
100mm	276BR08100BP	BR
	276CP08100BP	CP
	276FB08100BP	FB
	276SC08100BP	SC
	276SN08100	SN
	276SG08100	SG
150mm	276SS100BP	SS
	276BR10150	BR
	276CP10150	CP
	276FB10150	FB
	276SC10150	SC
	276SS150BP	SS
200mm	276BR10200	BR
	276CP10200	CP
	276FB10200	FB
	276SC10200	SC

To order separate hook eye only: 276**E



Door Stops



POPULAR



404 Door Stop Wall Mount

- Made from aluminium
- Concealed fixing
- Fixings supplied



Length 85mm Base size 32mm	404SN	SN
	202DS85A	SA
	202DS85APB	MB
	202SG85A	SG
	2020585MBC	BC
5 Pack	202DS85A5PK	SA
	404SNB	SN
	202DS85APBB	MB
	202DS30AB	SA
		Length 30mm Base size 32mm



400 Door Stop Wall Mount

- Supplied with black and white tips
- Concealed fixing
- Fixings supplied

Length 80mm Base size 30mm	400SC	SC
	400SS (stainless steel)	SS
	400SCB	SC



403 Door Stop Wall Mount

Length 80mm Base size 30mm	403SG	SG
	403PB	MB



204 Door Stop Wall Mount

- Length 90mm - Base size 43mm
- Made from forged brass
- Rubber tip (fixed)
- Fixings supplied

	204SCB	SC
--	--------	----



203 Door Stop Wall Mount

- Made from aluminium
- Fixings supplied

Length 85mm Base size 38mm	203SC	
5 Pack	203SC5PK	SC



701 Door Stop Wall Mount

- Made from zinc diecast
- 3 screw face fixed
- Fixings supplied

Length 75mm Base size 37mm	701SC	SC
-------------------------------	-------	----





402 Door Stop Wall Mount

- Brushed stainless steel finish
- Concealed fixing

Length 80mm	402SS	SS
Base size 25mm		



601 Door Stop Wall Mount

- Concealed fixing
- Fixings supplied

Length 70mm	601SS	SS
Wide 25mm		

Length 100mm	601SS100	SS
Wide 25mm		



806 Door Stop Wall Mount

- Made from aluminium
- White and black tips supplied
- Fixings supplied

Length: 75mm	806SC	SC
	806SN	SN
	806SG	SG
	806PB	MB



Round with Straight Edge Round Tip Wall Mount

- Made from aluminium
- White and black tips supplied
- Fixings supplied

Length: 75mm	804SC	SC
	804SN	SN



207 Floor Mount Door Stop - 2 Piece



- Made from aluminium
- Suits concrete and timber floors
- Supplied with 6mm dynabolt, masonry anchor and timber fix screw

Height 40mm	207SC2	2 piece	SC
Base size 38mm			

TRADE PACK	207SC2B	2 piece	SC
	207PB2B	2 piece	MB



609 Door Stop Floor Mount

- Made from stainless steel
- Concealed fixing
- Fixings supplied

Height 40mm	609SS	SS
Base size 25mm		



809 Door Stop Floor Mount

- Made from zinc diecast
- Concealed fixing
- Fixings supplied

Height 40mm	809SN	SN
Base size 40mm	809SG	SG
	809PB	MB



602 Door Stop Floor Mount

- Made from stainless steel
- Fixings supplied

Height 35mm	602SS	SS
Base size 45 x 30mm		



Door Stop Floor Mount Satin Chrome

- Made from zinc diecast
- Fixings supplied

Overall height 48mm	9872SSC	SC
Base size 60 x 50mm		



Left hand image shown



Overhead Door Stop with White Rubber

- Length 160mm
- Stainless steel finish
- Made from stainless steel, SS304
- Supplied with 4 x wood screws
- Left or right hand options available

Left Hand	763SSL	SS
Right Hand	763SSR	SS
TRADE PACK	763SSLB	SS
	763SSRB	SS



One Piece Auto Door Holder

- Stainless steel finish
- Suitable for doors with door closers: foot operated
- Uses the weight of the door to hold open

807SN	SS
-------	----



705 Magnetic Door Stop Wall or Floor Mount

- Magnet catch: 50mm diameter x 10mm
- Sprung striker
- Concealed fixing
- Fixings supplied

Length 75mm	705SC	SC
Base size 50mm		



808 Magnetic Door Stop Wall or Floor Mount

- Satin nickel finish
- Adjustable length 80-95mm
- Concealed fixings
- Fixings supplied

808SN	SN
808SC	SC
808PB	MB
808SG	SG



714 Magnetic Door Stop Wall or Floor Mount

- Made from zinc diecast
- Magnet catch: 30mm diameter x 15mm high
- Concealed fixing
- Fixings supplied

Length 80mm	714SN	SN
Base size 42mm	714PB	MB
	714SG	SG

703 Door Stop & Holder

- Made from zinc diecast
- 3 screw face fixed
- Fixings supplied



Length 75mm	703SC	SC
Base size 40mm		



Door Stop and Hook

- Made from zinc diecast
- Black tip
- Fixings supplied

Length 90mm	702SC	SC
Base size 40mm		



Door Stop and Hook

- Centre door fix
- Concealed fixing
- Fixings supplied

Length 95mm	604SS	SS
Base size 50mm		



Door Stop and Hook

- Stainless door stop with coat hook pin
- Short length 50mm for partitioned doors
- Door must be minimum 20mm thick
- Fixing supplied

223SS	SS
-------	----



Cushioned Door Stop Wall Mount

- Plastic cushion type
- Concealed fixing
- Fixings supplied

Length 35mm	605PW	PW
Base size 75mm		

TRADE PACK	605PWB	PW
------------	--------	----



218 Latching Door Stop Wall Mount

- Powder coated
- Square base with 4 screw fixings
- Swivelling latch
- Fixings supplied

Length 75mm	218SC	SC
Base size 45mm		



600 Latching Door Stop Wall Mount

- Powder coated
- Swivelling latch
- Fixings supplied

Length 80mm	600SC	SC
Base size 45mm		

600PW	PW
-------	----

600PB	MB
-------	----

600RM	RW
-------	----



277 Latch Back

- Made from brass
- Secure latch back function
- Fixings supplied

Length 65mm	277SC	SC
Base size 60 x 38mm		





**Heavy Duty Latch Back
Wall Mount Door Stop 60mm**

- Made from forged brass
- Heavy duty suitable for commercial use
- Latch base size: 70 x 46mm
- Keeper plate 40mmW x 64mmL
- Self latching
- Fixings supplied



**Mantis Latching
Door Stop Wall Mount**

- Made from forged brass
- Latch base size: 40 x 60mm
- Self latching with foot release
- Keeper plate 40 x 40mm
- Attached length base to base: 80mm
- Fixings supplied

609SCWM SC

609SGWM SG



DESIGNED BY
MILES NELSON



**Foot Operated Release
Door Stop Wall Mount**

- Powder coated finish
- Latch length 80mm
Base size 50 x 28mm
- Catch 38 x 20mm
- Suitable for left or right opening doors
- Self latching
- Fixings supplied

700SC SC



DESIGNED BY
MILES NELSON



**Mantis Latching
Door Stop Floor Mount**

- Made from forged brass
- Latch height 125mmH
Base size 42mmW x 55mmL
- Keeper plate 40 x 40mm
- Self latching with foot release
- Fixings supplied

609SC SC

609SG SG



DESIGNED BY
MILES NELSON



**Heavy Duty Latch Back Floor
Mount Door Stop**

- Made from forged brass
- Heavy duty suitable for commercial use
- Latch height 90mm (145mm for 608SC150) Base size 46mmW x 70mmL
- Keeper plate 40mmW x 64mmL
- Self latching with foot release

608SC SC

608PB MB

608SC150 SC

608SCB SC

608SC150B SC



Pedestal Door Holder

- Made from aluminium satin chrome anodised
- Height 280mm
- Upstand 50 x 50mm
- Base 90mm x 90mm
- Supplied with concrete screws

Pedestal including 277SC Auto Latch back 618SC SC

Pedestal including 600SC Manual Latch back 619SC SC

Pedestal including 600PB Manual Latch back 619PB MB



Hooks

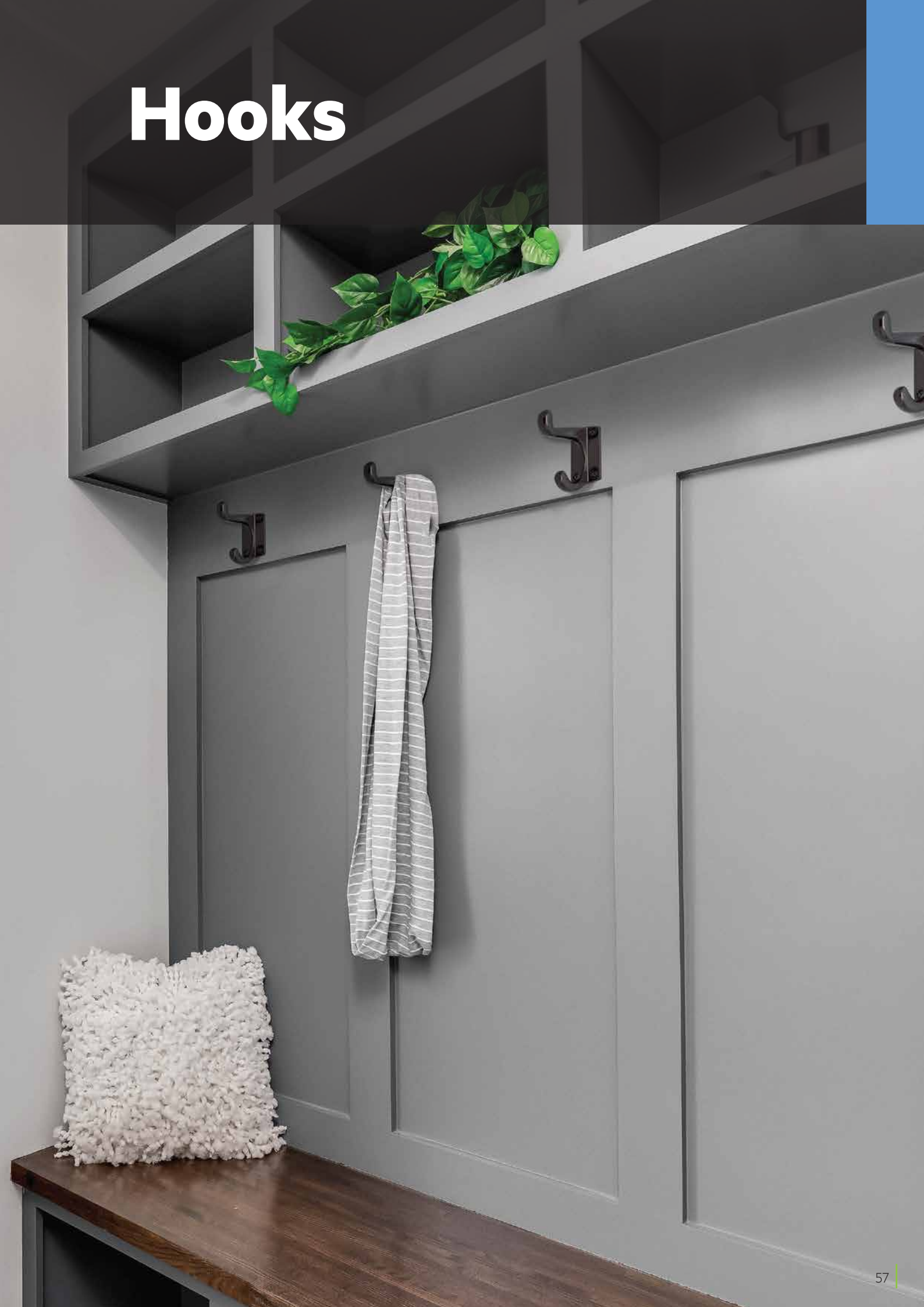

Cabinet Hardware and Handles



Hat & Coat Hook

- Made from aluminium
- Fixings supplied

273SC	SC
273SC10PK 10 Pack	SC
273SC5PK 5 pack	SC
273SCB 	SC
273CP	CP
273FB	FB
273PB	MB



Hat & Coat Hook

- Made from zinc diecast
- Fixings supplied

102SC	SC
102CP	CP
102FB	FB
102PW	PW
102GD	GD



Robe hook

- Chrome on brass
- Concealed fixing
- Fixings supplied

494CP	CP
-------	----

5 YEAR WARRANTY



Door Stop and Hook

- Length 90mm Base size 40mm
- Fixings supplied

702SC	SC
-------	----



Door Stop and Hook

- Stainless steel door stop with coat hook pin
- Door must be minimum 20mm thick
- Short length 50mm for partitioned doors
- Fixing supplied

223SS	SS
-------	----

 **QUALITY STAINLESS STEEL**



Door Stop And Hook

- Length 95mm Base size 50mm
- Centre door fix
- Concealed fixing
- Fixings supplied

604SS	SS
-------	----

 **QUALITY STAINLESS STEEL**



Wardrobe Hook

- Zinc diecast
- Fixings supplied

103SC	SC
103CP	CP
103FB	FB
103PW	PW
102GD	GD



Wardrobe Hook

- Made from aluminium
- Fixings supplied

274SC	SC
274CP	CP
274FB	FB





Wardrobe/Cupboard Handle

- Overall size 226mm
- Size CC 192mm
- Projection 27mm
- Supplied with 38mm and 22mm screws

0651BN3061XXL	SN
0651SC3061XXL	SC
0651BLK3061XXL	MB



General Purpose Handle

- Made from zinc diecast
- Fixings supplied

	088CP114	CP
114mm	088FB114	FB
	088SC114	SC
	088CP150	CP
150mm	088FB150	FB
	088SC150	SC



D Handle

- Made from solid brass
- 30mm projection
- Supplied with 2 x 30mm screws

	261SC0875	SC
8 x 75mm	261CP0875	CP
	261SC0896	SC
8 x 96mm	261CP0896	CP
	261SC1096	SC
10 x 96mm	261CP1096	CP
	261SC10160	SC
10 x 160mm	261CP10160	CP



Concave Knob 38mm

- Made from zinc diecast
- 17mm base
- 38mm diameter
- Supplied with 1 x 30mm screws

065CP38	CP
---------	----



Double Ball Catch

- Made from solid brass
- Adjustable tension
- Fixings supplied

50mm	708BR50	PB
60mm	708BR60	PB



Cupboard Catch

- Made from zinc diecast
- Fixings supplied

099CP	CP
-------	----

Bannister Brackets

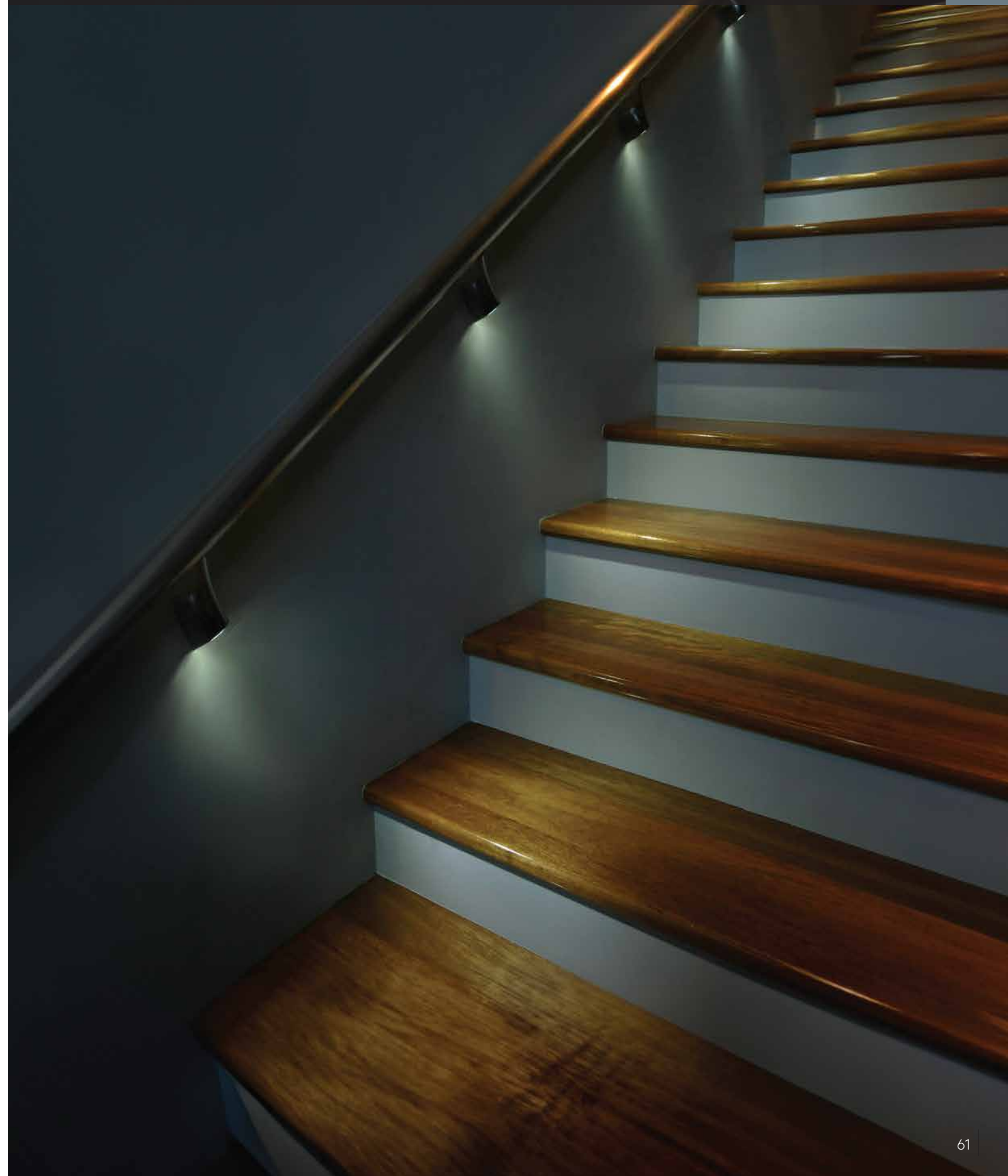



The revolutionary Lumos® LED bannister bracket seamlessly blends function and design by providing lighting within a bannister or railing bracket body.

This development simplifies the installation of safety or railing illumination into one stylish bracket.

The brackets use low energy consumption LED bulbs with a life of approximately 12 years under continuous use. The light does not

produce heat and is therefore safe to touch. Recommended bracket spacing is 900mm, as light coverage area at maximum height is 900mm. One transformer can power up to 16 brackets containing LEDs.

Requires the use of a Miles Nelson regulated power transformer, supplied separately. Complies with BIA acceptable solution D1/AS1. Can also be used with photosensitive sensors for night lighting.

Lumos Brackets are designed and manufactured in New Zealand.

- Lumos® bannister bracket
- 12 volt LED downlight
- Very low power consumption
- Cool running
- Adapter for flat profile rails
- Concealed fixing
- Fixings supplied

Indoor use	610SCBP	SC
Powder coated finish for outdoor use	610SCEBP	SC
Lumos bulb spare part	610LED	SC
Indoor use (without light)	611SCBP	SC
	611CP	CP
Powder coated finish for outdoor use (without light)	611SCEBP	SC

Lumos® Transformer

- 12 volt
- Each transformer can power 16 lights
- Tested to AS/NZS3108 at 25°C

612PA



INTERIOR/EXTERIOR USAGE

 DESIGNED BY MILES NELSON

Specifications Diagram

Base: 70mmH x 50mmW x 52mmD
 Wall projection: 70mm
 Upstand height: 80mm
 Overall height: 115mm

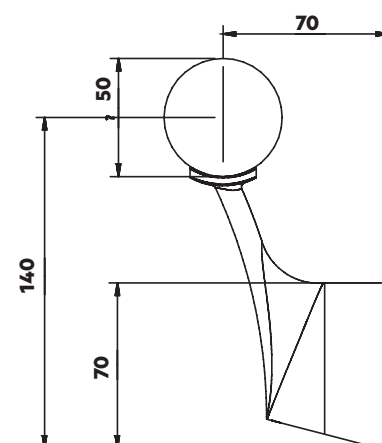

With glass fixing bracket*

810 Bannister Bracket SS316

- Polished 316 marine-grade stainless steel
- Suitable for exterior use
- Concealed fixing
- Fixings supplied
- Removable saddle
- Base diameter: 55mm
- Wall projection: 78mm
- Upstand height: 75mm

810SSWB1	316 marine-grade stainless steel	PS
810SSGFK	Glass fixing kit	PS
810SSA	Flat rail adapter	PS

*8mm through fixing (14mm minimum hole size)

INTERIOR/EXTERIOR USAGE

 316 MARINE GRADE STAINLESS STEEL

DESIGNED BY MILES NELSON
 Tested to 820kg Static Load
 Test Certificate No.: INZ70574-01

5 YEAR WARRANTY

 INTERIOR USAGE

 DESIGNED BY MILES NELSON

810 Bannister Bracket

- Concealed fixing
- Includes flat rail adapter
- Supplied with hanger bolt
- Base: 30mm
- Wall projection: 70mm
- Upstand height: 60mm
- Fixings supplied

810SC1	SC
810SN1	SN
810SG	SG
810PB	MB



810 Bannister Bracket with Rose

- Concealed fixing
- Base diameter: 55mm
- Wall projection: 78mm
- Upstand height: 60mm
- Fixings supplied
- Includes flat rail adapter

810SCWB1	SC
810SGWB	SG
810SNWB1	SN
810PBWB	MB

INTERIOR USAGE

 5 YEAR WARRANTY

DESIGNED BY MILES NELSON
 Tested to 409kg Static Load
 Test Certificate No.: INZ70574-01

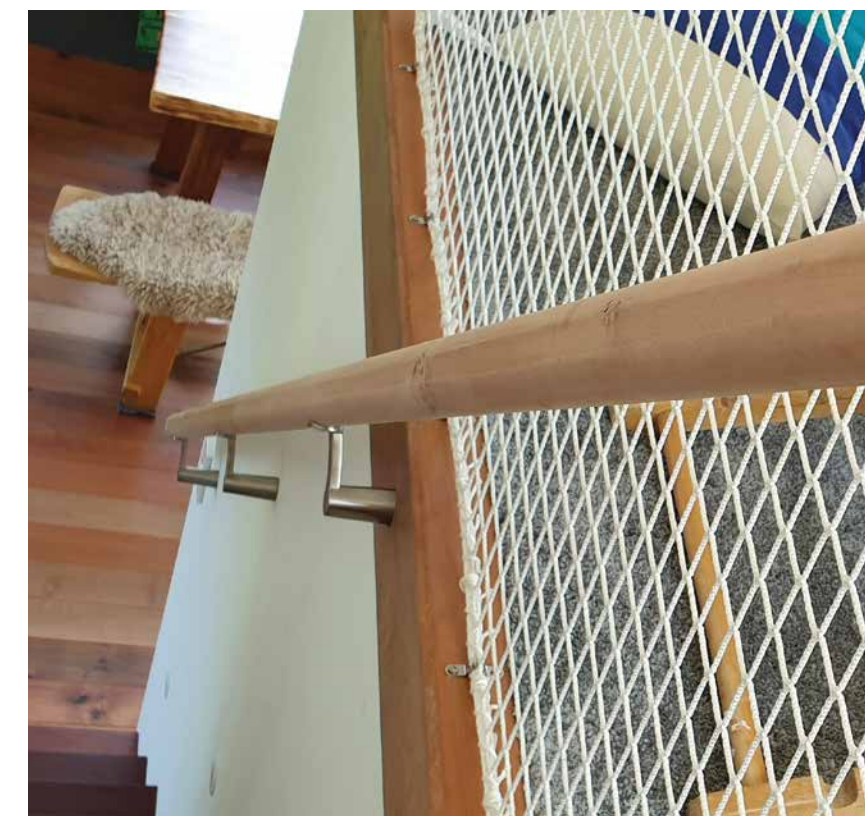



410 Bannister Bracket

- Made from zinc diecast
- Suits square and round rails
- Includes flat rail adapter
- Concealed fixing
- Fixings supplied
- Base: 55 x 45mm
- Wall projection: 75mm
- Upstand height: 65mm

410SC SC

5 YEAR WARRANTY **DESIGNED BY MILES NELSON**



312 Bannister Bracket

- Made from zinc diecast
- Complies with BIA acceptable solution D1/AS1
- Suits square and round rails
- Includes flat rail adapter
- Base: 58 x 58mm
- Wall projection: 75mm
- Upstand height: 75mm
- Concealed fixing
- Fixings supplied

312SC SC

312SN SN

5 YEAR WARRANTY **DESIGNED BY MILES NELSON**



310 Bannister Bracket

- Made from zinc diecast
- Complies with BIA acceptable solution D1/AS1
- Tested to 300kg static load
- Suits square and round rails
- Includes flat rail adapter
- Concealed fixing
- Fixings supplied
- Base diameter: 58mm
- Wall projection: 75mm
- Upstand height: 75mm

310SC SC

310SCB SC **TRADE PACK**

310SC3PK (3 pack) SC

310CP CP

310BR BR

310SN SN

310SNB SN **TRADE PACK**

310PB MB

310PBB MB **TRADE PACK**

310PW PW

310RM (uncoated for custom finish) RW

310FB FB

310SG SG

5 YEAR WARRANTY **DESIGNED BY MILES NELSON**



621 Bannister Bracket

- Made from 316 grade stainless steel
- Suits commercial applications
- Suitable for exterior use
- Includes flat rail adapter
- Base: 65mm
- Wall projection: 78mm
- Upstand height: 75.5mm
- Concealed fixing
- Fixings supplied

621SS SS

INTERIOR/ EXTERIOR USAGE

316 MARINE GRADE STAINLESS STEEL



309 Bannister Bracket

- 304 grade stainless steel satin finish
- Suitable for exterior use
- Base: 60mm
- Wall projection: 75mm
- Upstand height: 70mm
- Fixings supplied

309SS SS

309SSB SS **TRADE PACK**

INTERIOR/ EXTERIOR USAGE

316 MARINE GRADE STAINLESS STEEL



311 Bannister Bracket

- Made from zinc diecast
- Suits square and round rails
- Includes flat rail adapter
- Base diameter: 58mm
- Upstand height: 80mm
- Concealed fixing
- Fixings supplied

311SC SC

5 YEAR WARRANTY **DESIGNED BY MILES NELSON**



313 Bannister Bracket

- Made from zinc diecast
- Suits square and round rails
- Base: 58 x 58mm
- Upstand height: 80mm
- Includes flat rail adapter
- Concealed fixing
- Fixings supplied

313SC SC

5 YEAR WARRANTY **DESIGNED BY MILES NELSON**



405 Bannister Bracket

- 304 grade stainless steel satin finish
- Galvanised steel inner base plate
- Includes flat rail adapter
- Base: 50mm
- Wall projection: 85mm
- Upstand height: 55mm
- Fixings supplied

405SS SS

INTERIOR/ EXTERIOR USAGE

QUALITY STAINLESS STEEL



620 Bannister Bracket

- Made from 316 grade stainless steel
- Suits commercial applications
- Suitable for exterior use
- Base: 65mm
- Wall projection: 78mm
- Upstand height: 75.5mm
- Concealed fixing

620SS SS

INTERIOR/ EXTERIOR USAGE

316 MARINE GRADE STAINLESS STEEL



210 Bannister Bracket

- Made from cast aluminium
- Powder coated
- Base: 55mm
- Wall projection: 75mm
- Upstand height: 45mm
- Fixings supplied

210SC	SC
210SCB	SC
210SC3PK (3 pack)	SC



110 Bannister Bracket

- Made from zinc diecast
- Base: 45 x 50mm
- Wall projection: 60mm
- Upstand height: 75mm
- Fixings supplied

110SC	SC
110CP	CP
110FB	FB
110PW	PW



510 Bannister Bracket

- Made from solid brass
- Suits square and round rails
- Base diameter: 50mm
- Wall projection: 80mm
- Upstand height: 50mm
- Concealed single point fixing
- Fixings supplied includes hanger bolt
- Anchor fix

510SC	SC
510BR	PB



511 Bannister Bracket

- Made from solid brass
- Suits square and round rails
- Fixings supplied
- Base diameter: 50mm
- Upstand height: 55mm

511SC	SC
-------	----



512 Bannister Bracket

- Made from solid brass
- Suits square and round rails
- Base diameter: 57mm
- Wall projection: 75mm
- Upstand height: 60mm
- Concealed fixing
- Fixings supplied

512SC	SC
512SN	SN
512SG	SG



813 Bannister Bracket

- Made from 304 solid Stainless Steel
- Flat handrail adaptor available separately
- Base diameter: 55mm
- Wall projection: 74mm
- Upstand height: 51mm
- Concealed fixing
- Fixings supplied

Bannister Bracket	813SS	SS
	813SSB	SS
Adaptor Plate	813SSA	SS



Window Fittings





Casement Stay – Brass

- Made from solid brass
- For side hinged / casement windows
- Suitable for sealed windows
- Imperial sizing
- Fixings supplied

Size: 300mm	463SC300	SC
	463CP300	CP
	463BR300	PB
	463FB300	FB
	463PB300	MB
	463SG300	SG
	463SN300	SN
Size: 350mm	463SC350	SC
	463CP350	CP
	463BR350	PB
	463FB350	FB
	463SN350	SN

B BRASS LIFETIME GUARANTEE

TRADE PACK

Size: 300mm	463SC300B	SC
	463CP300B	CP
	463BR300B	PB
	463FB300B	FB

TRADE PACK

Size: 300mm	463SC350B	SC
	463CP350B	CP
	463BR350B	PB
	463FB350B	FB

Locking Set Codes:
463SCL, 463CPL, 463BRL, 463FBL, 463SNL
Packer Codes: 464CP, 464SC, 464BR, 464SN



Fanlight Stay – Brass

- Made from solid brass
- For use on side-hinged / casement and top-hinged / awning windows
- Suitable for sealed windows
- Fixings supplied

Size: 250mm	465SC250	SC
	465CP250	CP
	465BR250	PB
	465FB250	FB
	465SN250	SN
	465SG250	SG
Size: 300mm	465SC	SC
	465CP	CP
	465BR	PB
	465FB	FB
	465SN	SN
	465SG	SG
	465MB	MB

B BRASS LIFETIME GUARANTEE

TRADE PACK

Size: 250mm	465SC250B	SC
	465CP250B	CP
	465FB250B	FB

TRADE PACK

Size: 300mm	465SCB	SC
-------------	--------	----

Packer Codes: 464CP, 464SN
Pin Codes: 465CP, 465SN



Casement Stay – Zinc

- Zinc alloy components with brass rod
- For side hinged / casement windows
- Suitable for sealed windows
- Fixings supplied

Size: 355mm	912SC355	SC
	912CP355	CP
	912BR355	BR
	912FB355	FB
	912PW355	PW

10 YEAR WARRANTY



Fanlight Stay – Zinc

- Zinc alloy components with brass rod
- For use on side-hinged / casement and top-hinged / awning windows
- Suitable for sealed windows
- Fixings supplied

Size: 305mm	913SC305	SC
	913CP305	CP
	913BR305	BR
	913FB305	FB

Pins: 465CPP

10 YEAR WARRANTY

Fittings for Steel Windows



Fanlight Stay

- Solid brass
- Angled base to fit narrow steel frame

Size: 250mm (left hand)	466SCLH	SC
Size: 250mm (right hand)	466SCRH	SC

Order left hand when fixing cage to left hand sill.
Note we do not supply fixings with this product.

B BRASS LIFETIME GUARANTEE



Wind Stay

- Solid brass
- Secures windows in high wind
- Suitable for heavy windows
- Option when friction stays worn out
- Non-handed

470SC	SC
-------	----

Note we do not supply fixings with this product

B BRASS LIFETIME GUARANTEE



Nippy Latch

- Solid brass
- Spring loaded self latching
- Screw fix spacings 20mm CTC

471SC	SC
-------	----

Note we do not supply fixings with this product

B BRASS LIFETIME GUARANTEE



Telescopic Stay – Brass

- Made from solid brass
- For use on side-hinged/ casement windows
- Suitable for sealed windows
- Metric M6 thumb screw thread
- Fixings supplied

Size: 245mm, 378mm extended	246SC	SC
	246SCB	SC
	246CP	CP
	246BR	PB
	246FB	FB
	246PB	MB
	246SN	SN
	246SG	SG

TRADE PACK

Thumb Screw Codes:
247SC, 247CP, 247FB, 247BR, 247SN, 247SG, 247MB



Restricted Telescopic Stay

- Made from solid brass
- Suitable for sealed windows
- For use on side/casement windows
- Metric M6 thumb screw thread
- Fixings supplied

Size: 140mm, 190mm extended	248SC	SC
	248CP	CP
	248BR	PB
	248FB	FB
	248PB	MB
	248SN	SN
	248SG	SG

B BRASS LIFETIME GUARANTEE



DESIGNED BY MILES NELSON

Telescopic Stay – Zinc

- Zinc alloy components with brass rod and body
- For use on side-hinged/casement windows
- Traditional thumb screw operation
- Suitable for retro fit
- Suitable for sealed windows
- Fixings supplied

Size: 200mm	917SC200	SC
	917CP200	CP
	917BR200	BR
	917FB200	FB
	917PW200	PW

Thumb Screw Codes:
917SC, 917CP, 917FB, 917PW

5 YEAR WARRANTY **B** BRASS LIFETIME GUARANTEE



DESIGNED BY MILES NELSON

Windlock Stay

- Made from solid brass
- Spring action fingerplate for multiple locating positions
- For use on side/casement windows
- Fixings supplied
- Suitable for sealed windows

Size: 245mm, 378mm extended	264SC	SC
	264CP	CP
	264BR	PB
	264FB	FB
	264SN	SN
	264PB	MB

B BRASS LIFETIME GUARANTEE



Quadrant Stay – Brass

- Made from solid brass
- For use on top-hinged windows
- Suitable for sealed windows
- Fixings supplied

233SC	SC
233CP	CP
233PB	MB
233BR	BR
233FB	FB
233SG	SG

Size:
37mm x 13mm

Thumb Screw Codes:
234SC, 234CP, 234FB, 234BR



Windlock Fastener

- Made from solid brass
- For use on top and side-hinged windows
- Suitable for sealed windows
- Fixings supplied

266SC	SC
266CP	CP
266BR	BR
266FB	FB
266SN	SN
266PB	MB
266SG	SG



Spur Fastener

- Made from zinc diecast
- For use on casement windows
- Suitable for sealed windows
- Fixings supplied

915SC	SC
915CP	CP
915BR	BR
915FB	FB
915PW	PW



Spur Fastener

- Made from solid brass
- Suitable for sealed windows
- For use on top window hinge
- Fixings supplied

48SC4320	SC
48CP4320	CP
48FB4320	FB
48PB4320	MB
48SG4320	SG



Sash Fastener

- Made from solid brass
- For use on casement windows
- Suitable for sealed windows
- Fixings supplied

48SC4036	SC
48CP4036	CP
48BR4036	BR



916 Wedge Fastener

- Made from zinc diecast
- For use on casement windows
- Suitable for sealed windows
- Fixings supplied

916SC	SC
916CP	CP
916BR	BR
916FB	FB
916PW	PW



918 Wedge Fastener

- Made from solid brass
- For use on casement windows
- Suitable for sealed windows
- Fixings supplied

918SC	SC
918CP	CP
918BR	BR
918FB	FB
918PW	PW



055 Split Rail Fastener

- Made from zinc diecast
- For use on top and side hinged windows
- Suitable for sealed windows
- Fixings supplied

055SCL	SC
055SCR	SC
055CPL	CP
055CPR	CP
055BRL	BR
055BRR	BR
055FBL	FB
055FBR	FB
055SNL	SN
055SNR	SN
055PWL	PW
055PWR	PW
055PBL	MB
055PBR	MB
055SGL	SG
055SGR	SG



Quadrant Stay

- Made from zinc diecast
- For use on top hung windows
- Suitable for sealed windows
- Fixings supplied

033SC	SC
033CP	CP
033FB	FB
033BR	BR

Screw & Base Code:
035SC, 035CP, 035FP, 035BR
Screw Codes:
034SC, 034CP, 034FP, 034BR



Sash Lift

- Made from solid brass
- Suitable for vertical sliding windows
- Fixings supplied

48SC4015	SC
48CP4015	CP
48BR4015	BR
48SG4015	SG



914 Split Rail Fastener

- Made from zinc diecast
- For use on top and side hinged windows
- Suitable for sealed windows
- Fixings supplied

914SCLH	SC
914SCRH	SC
914CPLH	CP
914CPRH	CP
914BRLH	BR
914BRRH	BR
914FBLH	FB
914FBRH	FB



236 Split Rail Fastener

- New design
- Suitable for sealed windows
- Fixings supplied
- No packer required
- Extended tongue



236SCL	SC
236SCR	SC
236CPL	CP
236CPR	CP
236PBL	MB
236PBR	MB
236BRL	BR
236BRR	BR
236SGL	SG
236SGR	SG
236SNL	SN
236SNR	SN



Window Cleats

- Made from zinc diecast
- Fixings not included

Size: 60mm 058BR Brass finish BR
Size: 100mm 059BR Brass finish BR



Left hand images shown

Timber / Aluminium Window Fastener

- Fits timber and aluminium windows
- New or retrofit applications
- Suitable for weather sealed timber windows
- Timber and aluminium fixings included
- 32mm centre to centre fixing
- Fixing supplied

NZ Design application #428087

241BLKLH	MB
241BLKRH	MB
241SCLH	SC
241SCRH	SC

DESIGNED BY MILES NELSON



Right hand images shown

Quad Window Fitting

PREMIUM

- Electro plated finish (hardwearing and durable)
- Available in four different finishes
- Matches Miles Nelson door handle finishes
- Suits timber windows with or without weather seals
- Modern styling
- Concealed fixing

268BLKLH	Left hand	MB
268BLKRH	Right hand	MB
268SGLH	Left hand	SG
268SGRH	Right hand	SG
268SCLH	Left hand	SC
268SCRH	Right hand	SC
268BRLH	Left hand	BR
268BRRH	Right hand	BR

DURABLE ELECTROPLATED FINISH

DESIGNED BY MILES NELSON



Replacement aluminium window handle

- For use on aluminium or UPVC windows
- Suitable for awning or casement frames
- Easy retrofit and install
- Standard 32mm centre-to-centre fixing
- No fixings supplied

Low Profile	Self Latching Black	Left Hand	ASLPSLBLH	MB
Low Profile	Self Latching Black	Right Hand	ASLPSLBRH	MB
High Profile	Self Latching White	Left Hand	ASHPSLAWLH	PW
High Profile	Self Latching White	Right Hand	ASHPSLAWRH	PW
High Profile	Self Latching Black	Left Hand	ASHPSLBLH	MB
High Profile	Self Latching Black	Right Hand	ASHPSLBRH	MB



French Double Door Fastener

- Made from solid brass
- Fixings supplied

475BR	BR
475FB	FB
475CP	CP
475SC	SC
475SG	SG
475SN	SN

DB BRASS LIFETIME GUARANTEE

Gate Hardware

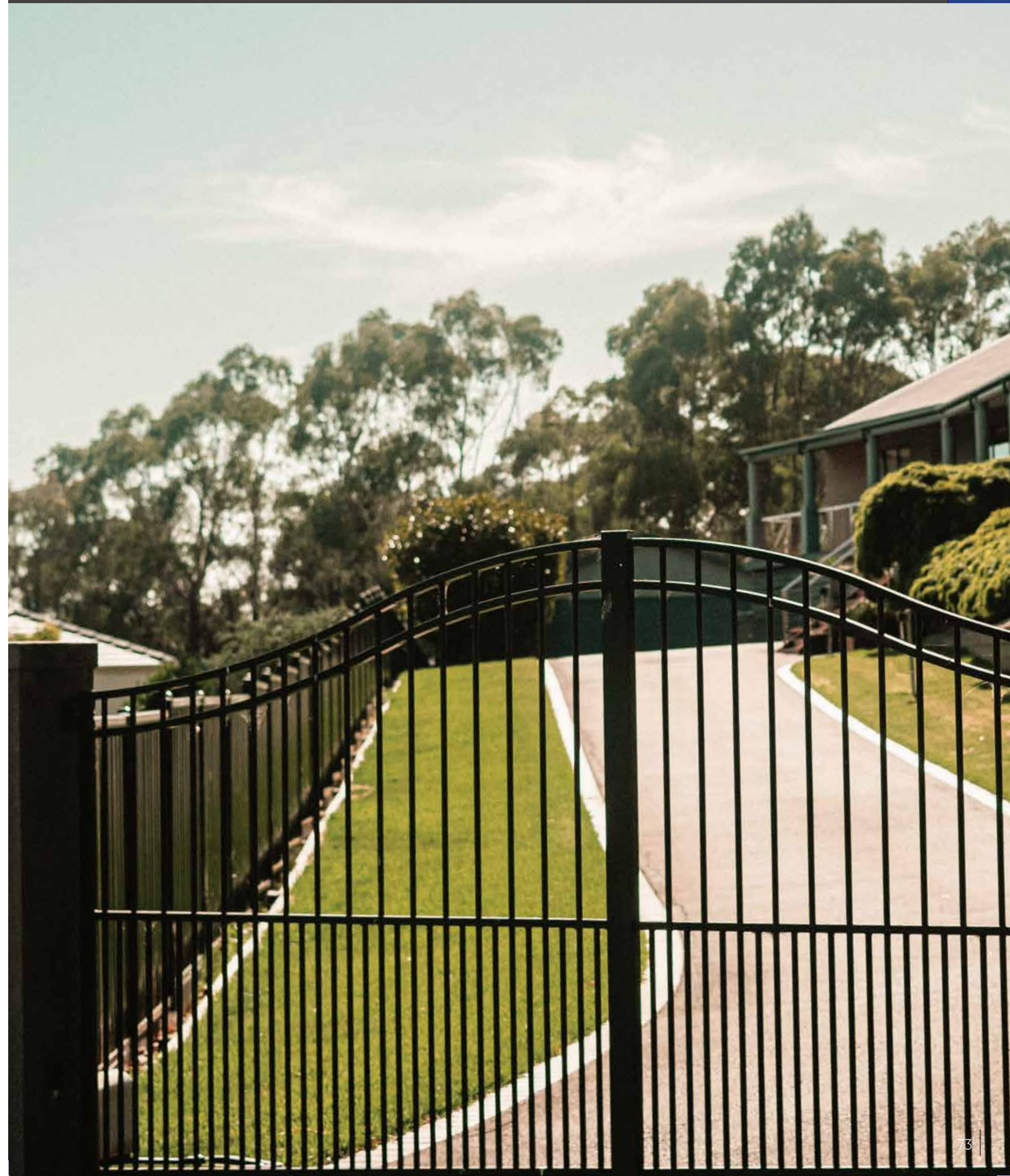

Safety and Security



Z ZINC PLATED

Gate Latch

- Easy to install gate latch
- Includes self-drill screws

284ZPGL



5 YEAR WARRANTY



Z ZINC PLATED

Padbolt

- Easy to install padbolt
- Includes self-drill screws

100mm 283ZPPB100

150mm 283ZPPB150



5 YEAR WARRANTY



Z ZINC PLATED

Hasp and Staple Safety

- Durable hasp and staple to secure toolboxes and chests
- Fixings included

115mm 286ZPHSS115

150mm 286ZPHSS150



5 YEAR WARRANTY



Z ZINC PLATED

Strap Hinge (Pair)

- Sturdy strap hinge ideal for outdoor use with an easy to install design
- Fixings included

100mm 520ZPSH100



5 YEAR WARRANTY



Z ZINC PLATED

T Hinge (Pair)

- Sturdy 'T' hinge ideal for outdoor use with an easy to install design
- Fixings included

150mm 520ZPTH150

200mm 520ZPTH200



5 YEAR WARRANTY



Z ZINC PLATED

Spring Coil Gate

- Sturdy self-closing spring coil for gates
- Fixings included

300mm 285ZPSCG300



5 YEAR WARRANTY





Window Opening Restrictor

- Suitable for aluminium windows
- Suitable for casement / awning windows
- Quality stainless steel construction
- Positive stop position
- Includes packers and screws

1 pair		
1 window	251REST2PK	
2 pair		
2 windows	251REST4PK	
20 pairs	No packers or screws	251RESTB
100 pairs	No packers or screws	251RESTB100



TRADE PACK

SUITABLE FOR L & R HAND APPLICATION

Window Opening Restrictor for Aluminium Windows

- Powder coat finish
- Restricts window opening
- Suitable for casement / awning windows
- 80-100mm opening
- Three locating positions
- Unique glide design for ease of use
- Quality construction
- Window can be fully opened when disengaged if required
- 2 recommended per window



1 piece pack	250SCA1	SC
	250PWA1	PW
	250PBA1	MB
2 piece pack	250PWA2	PW
	250PBA2	MB
4 piece pack	250SCA4	SC
	250PWA4	PW
	250PBA4	MB

SUITABLE FOR L & R HAND APPLICATION

Window Opening Restrictor for Timber Windows

- Powder coat finish
- Restricts window opening
- Suitable for casement / awning windows
- Three locating positions
- Unique glide design for ease of use
- Quality construction
- Window can be fully opened when disengaged if required
- 2 recommended per window

1 piece pack	250PWT1	PW
	250SCT1	SC
2 piece pack	250PWT2	PW
4 piece pack	250PWT4	PW
	250SCT4	SC

SUITABLE FOR L & R HAND APPLICATION

Patio Bolt

- Secure locking function
- Concealed screws for extra security
- Quality construction
- 45mm throw
- Unique slimline design
- Suitable for new weather sealed joinery
- Suitable for timber and aluminium
- DIY friendly installation
- Recommended for interior use only



1 piece pack	281PW1	PW
	281SC1	SC
	281PB1	MB
2 piece pack (key alike)	281PW2	PW
	281SC2	SC
	281PB2	MB
Key Blank	28 KEY	BR

Mini Bolt

- Secure locking function
- Concealed screws for extra security
- Quality construction
- 28mm throw
- Suitable for new weather sealed joinery
- DIY friendly installation
- Recommended for interior use only



1 piece pack	282PW1	PW
	282SC1	SC
	282PB1	MB
2 piece pack (key alike)	282PW2	PW
	282SC2	SC
	282PB2	MB
Key Blank	28 KEY	BR

Key Lock Box



- Portable and/or concealed fixing key safe box provides secure storage of keys or access cards
- Convenient push button locking mechanism in alpha/numeric telephone keypad format
- Set your own combination using up to 12 letters, numbers, or both
- Large buttons for ease of use, even in low light conditions
- Protective weather cover prevents freezing and jamming
- 2 options available: with and without shackle



Wall Mount	248298MN	MB
Shackle	248297MN	MB

Bathroom



The timeless **Casa Classica** range features clean lines and minimalist detailing, designed to compliment a wide variety of décor and bathroom styles.



Towel Ring

- Chrome on zinc diecast
- Concealed fixing
- Fixings supplied

593CP



3 YEAR WARRANTY



Robe Hook

- Chrome on brass
- Concealed fixing
- Fixings supplied

594CP



3 YEAR WARRANTY



Towel Rail

- Chrome on brass
- Non adjustable rail
- Concealed fixing
- Fixings supplied

Size: 600mm 595CP600



5 YEAR WARRANTY



Towel Ring

- Chrome on brass
- Concealed fixing
- Fixings supplied

892CP



5 YEAR WARRANTY



Towel Rail

- Chrome on brass
- Concealed fixing
- Fixings supplied

Size: 600mm 894CP600



5 YEAR WARRANTY



Toilet Roll Holder

- Chrome on zinc diecast
- Left handed
- Concealed fixing
- Fixings supplied

596CP (box pack)



3 YEAR WARRANTY



Toilet Brush Holder

- Chrome on brass
- Frosted glass holder
- Concealed fixing
- Fixings supplied

597CP



5 YEAR WARRANTY



Soap Holder

- Chrome on brass
- Glass dish
- Concealed fixings
- Fixing supplied

591CP



5 YEAR WARRANTY



Toilet Roll Holder

- Chrome on brass
- Left handed only
- Concealed fixing
- Fixings supplied

895CP



5 YEAR WARRANTY



Soap Dispenser

- Chrome on brass
- Concealed fixings
- Fixing supplied
- Removable bottle for easy cleaning

891CP



5 YEAR WARRANTY



Soap Holder

- Chrome on brass
- Concealed fixing
- Fixings supplied
- Removable dish for easy cleaning

890CP



5 YEAR WARRANTY

The **Rinnova** range sets the benchmark for contemporary design in bathroom accessories. Featuring clean balanced forms, functional design and careful detailing. Rinnova is the perfect range to update an existing bathroom, or complement quality fittings in a new bathroom.

Robe Hook

- Chrome on brass
- Base size 15 x 40 x 70mm
- Overall size 20 x 80mm
- Concealed fixing
- Fixings supplied



794CP CP

5 YEAR WARRANTY

Soap Dish

- Chrome on brass
- Concealed fixings
- Fixing supplied
- Removable glass for easy cleaning



791CP CP

5 YEAR WARRANTY



Toilet Roll Holder

- Chrome on brass
- Left handed only
- Base size 15 x 40 x 70mm
- Concealed fixing
- Fixings supplied

796CP CP

5 YEAR WARRANTY



Towel Rail

- Chrome on brass
- Base size 15 x 40 x 70mm
- Overall size 20 x 600mm
- Concealed fixing
- Fixings supplied

Size: 600mm 795CP600 CP

5 YEAR WARRANTY

Glass Holder

- Chrome on brass
- Base size 15 x 40 x 70mm
- Overall size 120 x 90mm
- Concealed fixing
- Fixings supplied



790CP CP

5 YEAR WARRANTY



Toilet Roll Holder

- Bright anodised aluminium
- Suitable for glass and timber partition walls
- Can be fixed left or right handed
- Adhesive fix only

922CP CP

5 YEAR WARRANTY



Toilet Roll Holder

- Chrome on steel, black nylon base
- Can be fixed left or right handed
- Fixings supplied

Rod: 6mm 919CP CP

5 YEAR WARRANTY



Toilet Roll Holder

- Brushed aluminium finish
- Suitable for commercial applications
- Can be fixed left or right handed
- Concealed fixing – single point hanger bolt
- Fixings supplied

Rod: 10mm 115SC SC

5 YEAR WARRANTY



Toilet Roll Holder

- Can be fixed left or right handed
- Fixings supplied

112CP CP

112SC SC

112PW PW

5 YEAR WARRANTY



Towel Ring

- Fixings supplied

114CP CP

114SC SC

114PW PW

5 YEAR WARRANTY



Towel Rail

- Rail diameter: 10mm
- Base diameter: 65mm
- Fixings supplied

400mm 116CP400 CP

600mm 116CP600 CP

5 YEAR WARRANTY



Tea Towel Rail – Steel

- Rail diameter: 8mm
- Base diameter: 38mm

230mm 921CP230 CP

921PW230 PW

300mm 921CP300 CP

921PW300 PW

406mm 921CP406 CP

921PW406 PW

457mm 921CP457 CP

921PW457 PW

610mm 921CP600 CP

921PW600 PW

5 YEAR WARRANTY

25mm Diameter Grab Rail Tube

- Polished 304 grade stainless steel
- Residential use only
- Knurled grip area
- Concealed screw fixing



Size: 300mm	530GR300SS	SS
Size: 400mm	530GR400SS	SS
Size: 900mm	530GR900SS	SS



25mm Diameter L Shape Tube

- Polished 304 grade stainless steel
- Residential use only
- Knurled grip area
- Concealed screw fixing
- 400 x 400mm L shape



535GRB400SS	SS	400mm
-------------	----	-------



25mm Diameter Angle Grab Rail Tube

- Polished 304 grade stainless steel
- Residential use only
- Knurled grip area
- Concealed screw fixing
- 45 degree curve

535GRB150SS	SS
-------------	----



For commercial use

32mm Diameter Grab Rail Tube

- 610mm straight
- Polished 304 grade stainless steel
- Penned grip area
- Concealed screw fixing
- Fixing supplied

MNC600GR	SS	32mm
----------	----	------



32mm Diameter L Shape Tube

- 750 x 750mm L shape
- Polished 304 grade stainless steel
- Penned grip area
- Concealed screw fixing
- Fixing supplied

MNC750GR	SS	32mm	750mm
----------	----	------	-------



Towel Rail End Bracket

- Packed in pairs
- For use with O25 tubing
- Fixings supplied

Suits 19mm tube	024SC19TBP	SC
	024CP19TBP	CP
	024PW19TBP	PW
	024PB19TBP	MB



Towel Rail Centre Bracket

- Packed in singles
- For use with O25 tubing
- Fixings supplied

Suits 19mm tube	024SC19CBP	SC
	024CP19CBP	CP
	024PW19CBP	PW
	024PB19CBP	MB



Towel Rail End Flange

- Packed in pairs
- For use with O25 tubing
- Fixings supplied

Suits 19mm tube	107SC19BP	SC
	107CP19BP	CP
	107PW19BP	PW
	107PB19BP	MB
Suits 25mm tube	107CP25	CP



Towel Rail End Bracket

- Packed in pairs
- For use with O25 and O26 tubing
- Fixings supplied

Suits 16mm tube	028CP16T	CP
Suits 19mm tube	028CP19T	CP
Suits 25mm tube	028CP25T	CP



Towel Rail Centre Bracket

- Packed in singles
- For use with O25 and O26 tubing
- Fixings supplied

Suits 16mm tube	028CP16C	CP
Suits 19mm tube	028CP19C	CP
Suits 25mm tube	028CP25C	CP



Towel Rail End Flange Round

- Packed in pairs
- For use with O25 and O26 tubing
- Fixings supplied

Suits 16mm tube	030CP16	CP
Suits 19mm tube	030CP19	CP
Suits 25mm tube	030CP25	CP



Towel Rail End Flange Oval

- Packed in pairs
- For use with O25 and O26 tubing
- Fixings supplied

Suits 16mm tube	029CP16	CP
Suits 19mm tube	029CP19	CP





Towel Rail Tubing – Aluminium

- Sizes: 600-2400mm
- Available in 19mm diameter

19mm Tubing

600mm	025CP19600	CP
	025SC19600	SC
	025PB19600	MB
	025PW19600	PW

900mm	025CP19900	CP
	025SC19900	SC
	025PB19900	MB
	025PW19900	PW

1200mm	025CP191200	CP
	025SC191200	SC
	025PW191200	PW

1800mm	025CP191800	CP
	025SC191800	SC
	025PB191800	MB
	025PW191800	PW

2400mm	025CP192400	CP
	025SC192400	SC
	025PW192400	PW



Towel Rail Tubing – Steel

- Sizes: 900-3600mm
- Available in 16mm, 19mm, 25mm diameters

16mm Tubing

900mm	026CP16900	CP
1200mm	026CP161200	CP
1800mm	026CP161800	CP
2700mm	026CP162700	CP
3000mm	026CP163000	CP

19mm Tubing

900mm	026CP19900	CP
1200mm	026CP191200	CP
1800mm	026CP191800	CP
2400mm	026CP192400	CP
2700mm	026CP192700	CP

25mm Tubing

900mm	026CP25900	CP
1200mm	026CP251200	CP
1800mm	026CP251800	CP
3600mm	026CP253600	CP



Towel Rail Tubing – Stainless Steel

- Sizes: 2000-3000mm
- Available in 19mm, 25mm diameters

19mm Tubing

2000mm	027SS192000	SS
--------	-------------	----

25mm Tubing

2000mm	027SS252000	SS
--------	-------------	----



Oval Rail Tubing

Sizes: 1200mm, 1800mm, 2400mm

15mm Tubing

1200mm	023CP151200	CP
1800mm	023CP151800	CP
2400mm	023CP152400	CP



Oval Rail Tubing End Support

1 Pair	023CP15	CP
--------	---------	----



Oval Rail Tube Centre Support

023CP15C	CP
----------	----



Oval Pillar End

1 Pair	023CP15T	CP
--------	----------	----



Oval Tube Hanging Hook

373CP	CP
-------	----





Indicator Bolt

- Made from zinc diecast
- Suitable for timber and metal doors
- Suit doors 28-45mm thick
- Surface mounted
- Screws supplied

3065SC



Indicator Bolt

- Made from 304 grade stainless steel
- Suitable for timber and metal doors
- Suit doors 28-45mm thick
- Surface mounted
- Screws supplied

710SS



Indicator Hook

- Stainless indicator hook
- Suits 28-50mm thick
- Surface mounted with 6 fixing points to choose
- 6mm square spindle
- Suit sliding and hinged doors

790SS



Roller Catch Ball

- Plastic diecast steel and brass
- 23 x 55mm
- Finish indicates striker colour
- Adjustable brass roller
- Fixings supplied

333SC



333SCB



333BR



Roller Catch Double

- Made from steel die-cast with zinc plating

334ZC

334ZCB



Kick Plates, Numbers and Letters

Quality numbers and letters in a contemporary font to identify street and apartment numbers for use on letterboxes, fences and walls.

Available in two sizes, in either concealed or adhesive fix, in a brushed stainless steel or matt black finish.

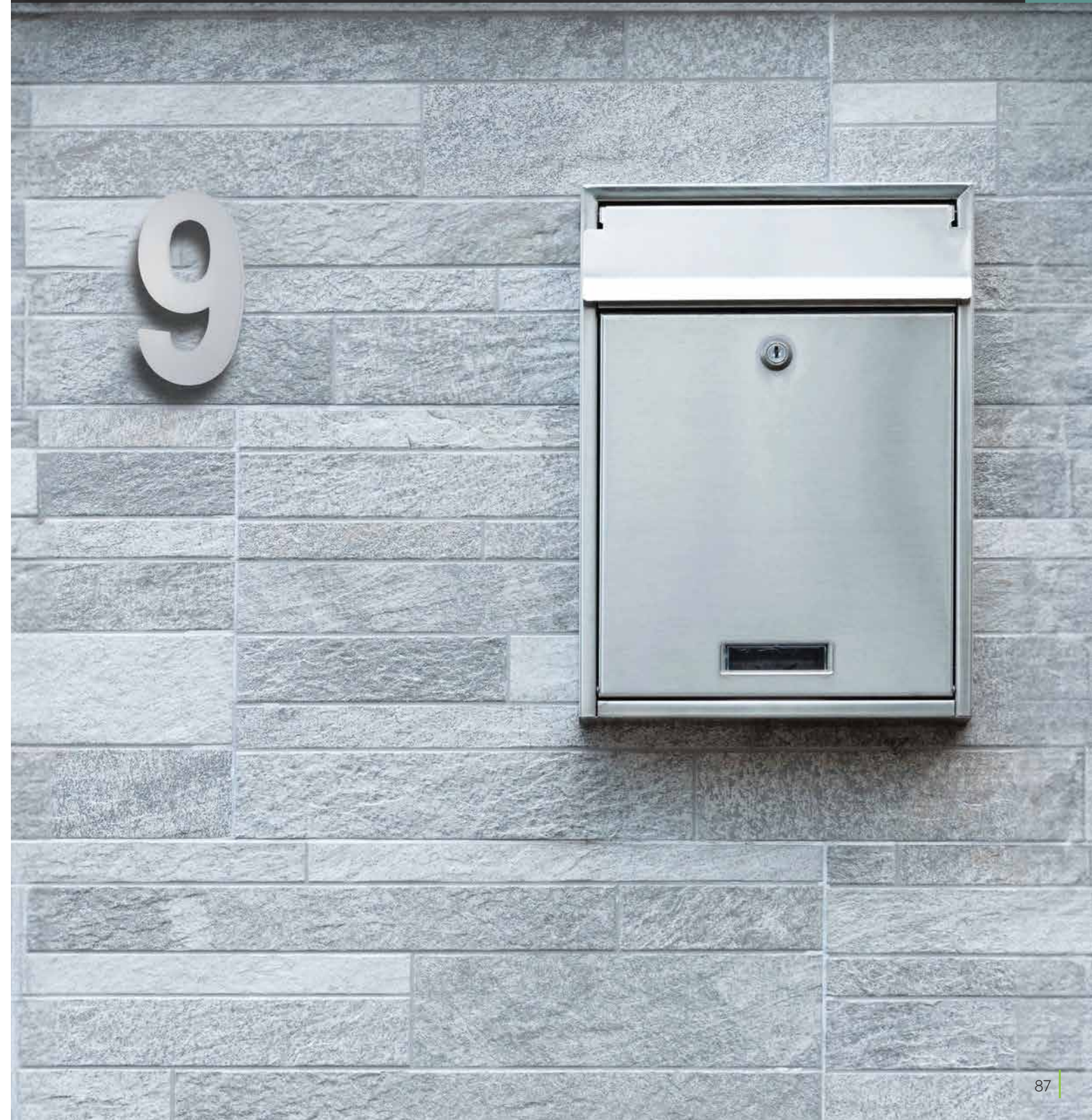



Kick Plate 200mm

- 304 grade stainless steel
- 200mmH
- Suitable for commercial applications
- Pre-drilled and countersunk holes
- Stainless steel screws supplied

Door size	Plate Width		
610mm	585mm	500KP610-200	SS
710mm	685mm	500KP710-200	SS
760mm	735mm	500KP760-200	SS
810mm	785mm	500KP810-200	SS
860mm	835mm	500KP860-200	SS
910mm	885mm	500KP910-200	SS



Kickplate 300mm

- Made from 304 grade stainless steel
- 300mm high
- 1.2mm thick
- Suitable for commercial applications
- Pre-drilled and countersunk holes
- Stainless steel screws supplied

Door size	Plate Width		
610mm	585mm	501KP610-300	SS
710mm	685mm	501KP710-300	SS
760mm	735mm	501KP760-300	SS
810mm	785mm	501KP810-300	SS
860mm	835mm	501KP860-300	SS
910mm	885mm	501KP910-300	SS



Push Plate 300mm



- Made from brushed 304 grade stainless steel
- Blank (not engraved) push plate
- 300 high x 100mm wide
- Suitable for commercial applications
- Fixings supplied

300mm	502PP300-100	SS
-------	--------------	----



Engraved Push Plate 300mm



- Made from brushed 304 grade stainless steel
- Engraved Push plate
- 300 high x 100mm wide
- Suitable for commercial applications
- Fixings supplied

300mm	502PPENGR	SS
-------	-----------	----



Engraved Pull Plate with Handle 300mm



- Made from brushed 304 grade stainless steel
- Engraved Pull plate
- 300 high x 100mm wide
- Suitable for commercial applications
- Fixings supplied

300mm	502PPENGRH	SS
-------	------------	----



Round Sign



- Made from brushed 304 grade stainless steel
- 'Push' sign for restroom doors
- Round 75mm diameter
- Suitable for commercial applications
- Fixings supplied

Baby Change	503PPTBC	SS
Wheelchair Accessible	503PPTDIS	SS
Men	503PPTM	SS
Men/Women	503PPTM/W	SS
Women	503PPTW	SS
Pull	503PULPR	SS
Push	503PUSPR	SS



Numbers 0-9 – Concealed Fix

- Made from 304 grade stainless steel
- Fixings supplied

100mm / 2mm thick

0	721SS1000	SS
	721PB1000	MB
1	721SS1001	SS
	721PB1001	MB
2	721SS1002	SS
	721PB1002	MB
3	721SS1003	SS
	721PB1003	MB
4	721SS1004	SS
	721PB1004	MB
5	721SS1005	SS
	721PB1005	MB
6	721SS1006	SS
	721PB1006	MB
7	721SS1007	SS
	721PB1007	MB
8	721SS1008	SS
	721PB1008	MB
9	721SS1009	SS
	721PB1009	MB



155mm / 2mm thick

0	721SS1550	SS
	721PB1550	MB
1	721SS1551	SS
	721PB1551	MB
2	721SS1552	SS
	721PB1552	MB
3	721SS1553	SS
	721PB1553	MB
4	721SS1554	SS
	721PB1554	MB
5	721SS1555	SS
	721PB1555	MB
6	721SS1556	SS
	721PB1556	MB
7	721SS1557	SS
	721PB1557	MB
8	721SS1558	SS
	721PB1558	MB
9	721SS1559	SS
	721PB1559	MB

Letters A-E – Concealed Fix

- Fixings supplied

100mm / 2mm thick

A	722SS100A	SS
	722PB100A	MB
B	722SS100B	SS
	722PB100B	MB
C	722SS100C	SS
	722PB100C	MB

D	722SS100D	SS
	722PB100D	MB
E	722SS100E	SS
	722PB100E	MB



On the following pages you find a selection of our COMMERCIAL RANGE.

To view our complete commercial hardware catalogue visit: milesnelson.co.nz or Scan the QR code:



- All kits are supplied with a fire rated mortice lock and forged brass door handles suitable for commercial and residential applications
- 25 year mechanical warranty on commercial mortice lock / 10 year warranty on handles
- Includes installation template and setup instructions
- Suitable for retro fitting and new installations
- Suitable for retail or trade



Fire Rated Door Hardware Kits



Entrance Lock Kit (Non-handed)

Components

- Mortice lock: MNC5000
- Lever: MNC151/90
Lever: MNC154/90
- Snib adaptor: MNCAD5200-01
- Key barrel: MNC570 incl keys

Product Code	Description	SC
MNCKITEL-NC	No key cylinder	SC
MNCKITEL	Includes 34mm key cylinder	SC
MNCKITEL-EXTC	Includes extended 41mm key cylinder (55-60mm doors)	SC



Storeroom Lock Kit (Non-handed)

Components

- Mortice lock: MNC5000
- Lever: MNC151/90
Lever: MNC156/90
- Key barrel: MNC570 incl keys
- Cams for storeroom & classroom functions

Product Code	Description	SC
MNCKITST-NC	No key cylinder	SC
MNCKITST	Includes 34mm key cylinder	SC
MNCKITST-EXTC	Includes extended 41mm key cylinder (55-60mm doors)	SC



Passage Set Kit (Non-handed)

Components

- Mortice lock: MNC5409
- Lever: MNC155/90
- Lever: MNC156/90

MNCKITPS	SC
----------	----



Large Turn Privacy Lock Kit (Non-handed)

Components

- Mortice lock: MNC5000
- Lever: MNC153I/90
- Lever: MNC154I/CLT/90
- Snib adaptor: MNCAD5200-01

MNCKITPRDA	SC
------------	----



Privacy Lock Kit (non-handed)

Components

- Mortice lock: MNC5000
- Lever: MNC153I/90
- Lever: MNC154/90
- Snib adaptor: MNCAD5200-01

MNCKITPR	SC
----------	----

The **5000 series mortise locks** have a 25 year mechanical warranty. The fire icon indicates a lock body that has been tested on a range of timber and mineral core doors. Check with your Miles Nelson representative for more information on fire ratings.

The **hydraulic 8000 series door closers** are an aluminium body finish and have a 10 year warranty. Products on this page with the fire icon have been tested on a range of timber and mineral core approved fire doors. Contact Miles Nelson for more information or check door manufacturers approved lists.

10 YEAR MILES NELSON WARRANTY



60mm Backset Mortise Lock

- 88mm case depth
- 8mm spindle hub, spindle supplied
- Suits up to 55mm thick door
- 41mm centre to centre rose fixings

MNC5000	SS
MNC5000-BLK	MB



60mm Backset Mortise Passage Latch

- 8mm spindle hub
- Non locking / no deadlatch

MNC5409	SS
---------	----



60mm Backset Mortise Deadbolt

- Zinc diecast body / stainless bolt

MNC5100	SS
MNC5100-BLK	MB



60mm Backset Mortise Sliding Door Deadbolt

- Zinc diecast body / stainless bolt

MNC5300	SS
MNC5300-BLK	MB



Latchbolt Rebate Kit

- For 5000 & 5409

MNC5000RK	SS
MNC5000RK-BLK	MB



Deadbolt Rebate Kit

- For 5100

MNC5100RK	SS
MNC5100RK-BLK	MB



Oval Key Cylinder

- Cylinder is 34mm overall
- Includes 2 keys (C4 profile)
- Suits up to 53mm thick door

MNC570	SC
MNC570KA (Keyed alike)	SC
MNC570-BLK	MB



Extended Oval Key Cylinder

- Cylinder is 41mm overall
- Suits 55-60mm thick door
- Includes 2 keys (C4 profile)

MNC570E	SC
MNC570EKA (Keyed alike)	SC
MNC570E-BLK	MB



Common Butterfly Adaptor

- Common turn adaptor
- Use with 5000 lock

MNCAD5200-01



Deadlock Sliding Lock Adaptor

- Use with 5100 and 5300 locks

MNCAD5100-01



EN3 - 4 Closer

- Adjustable back check/delay action function
- Includes parallel fixing bracket
- Adjustable closing and latching speeds
- Spare magnetic trim cover (MNC8404CP)

MNC8404BC/DA	SC
--------------	----



EN2 - 6 Closer (adjustable)

- Adjustable back check/delay action function
- Includes parallel fixing bracket
- Adjustable closing and latching speeds
- Spare magnetic trim cover (MNC8626CP)

MNC8626BC/DA	SC
MNC8626BC/DA-BLK	MB

Power Size	Model	Dimension (mm)			Hole Spacing (mm)		Applicable door weight (kg)	Applicable door width (mm)
		A	B	C	D	E		
EN3 - 4 Closer	MNC8404BC/DA	207	55	40	50	39	Up to 85	Up to 1100
EN2 - 6 Closer (adjustable)	MNC8626BC/DA	236	61	43	50	45	Up to 150	Up to 1400

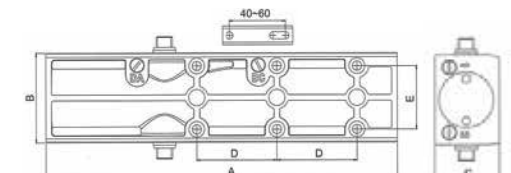

Door Selector

- For double doors
- Allow self latching doors to close in correct sequence
- Fixings included
- 300mm length

MNCD002	SS
---------	----



Hold Open Arm

- MNC8404HO suits MNC8404BC/DA
- MNC8626HO suits MNC8626BC/DA
- Ball joint for positive hold open

MNC8404HO	SC
MNC8626HO	



Slide Arm Kit

- MNC8404SA suits MNC8404BC/DA
- MNC8626SA suits MNC8626BC/DA
- Removable hold open feature
- Use of slide arm reduces closer power by 30%
- Fixings included

MNC8404SA	SC
MNC8626SA	SC
MNC8626SA-BLK	MB



Drop Plate

- Suits 8404 and 8626
- Fixings included

MNC8000DP	SC
-----------	----



Z Bracket

- Suits 8404 and 8626
- Fixings included
- For flush mount parallel fixing

MNC8000ZB	SC
-----------	----



Parallel Bracket Packer

- For use on aluminium joinery
- 10mm thick

MNC8000PAP	SC
------------	----



Wide Long Plate (Satin Chrome on Brass)

Quick handing change design door handle specifications:

Base: Length: 175mm

Width: 48mm

Depth: 11.5mm

Screwfix CTC: 158mm

Screw: M4

Spindle: 7.6mm

Material: Brass

Warranty: 10 year mechanical

- Disability compliant
- Retrofits most commercial handles
- All MNC handles come with screws to suit up to 55mm thick doors

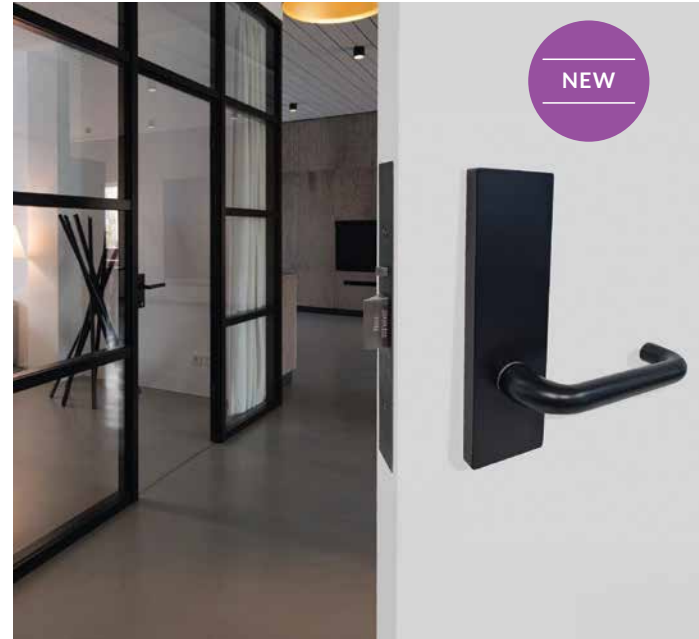

External with Lever and Cylinder Hole

MNC151/90 SC

MNC151/90BLK MB



External with Lever – no Cylinder Hole

MNC155/90 SC

MNC155/90BLK MB



External with Cylinder Hole – no Lever

MNC101 SC



External – no Lever or Cylinder Hole

MNC105 SC



External with Lever and Indicator and Release

MNC1531/90 SC

MNC1531/90BLK MB



Internal with Lever and Cylinder Hole

MNC152/90 SC

MNC152/90BLK MB



Internal with Lever – no Cylinder Hole

MNC156/90 SC

MNC156/90BLK MB



Internal with Lever and Turn (non-indicating)

MNC154/90 SC

MNC154/90BLK MB



Internal with lever and large turn (indicating non-handed)

MNC154iCLT/90 SC

MNC154iCLT/90BLK MB

Round Rose and Accessories



53mm Round Rose Lever Pair

- Satin Chrome on brass lever
- Screw on cover
- Screw fixing centre to centre 41mm
- Takes 7.6mm spindle

MNCR53/90 SC

MNCR53/90BLK MB



Screw for door thickness 55-65mm

- 80mm M4SS (pair)
- Suits up to 65mm door
- Use with R53 Rose Levers and accessories
- Break off sections

MNCR53SCREW



Round Rose Blank

- Fixings included for back to back and face fixing
- For back to back fixing use with MNCR53CE
- Screw on cover

MNCR53B SC



Turn Snib

- Fixings included for back to back and face fixing
- For back to back fixing use with MNCR53CE / MNCR53ER / MNCR53ERIND
- Screw on cover

MNCR53TS SC



Large Turn Snib (Indicating)

- Fixings included for back to back and face fixing
- For back to back fixing use with MNCR53CE / MNCR53ER / MNCR53ERIND
- Screw on cover
- Indicating

MNCR53TSDA SC

MNCR53TSDA-BLK MB



Emergency Release (Indicating)

- Fixings included for back to back and face fixing
- For back to back fixing use with MNCR53TS or MNCR53TSDA
- Screw on cover

MNCR53ERIND SC

MNCR53ERIND-BLK MB



Emergency Release (Non-Indicating)

- Fixings included for back to back and face fixing
- For back to back fixing use with MNCR53TS or MNCR53TSDA
- Screw on cover

MNCR53ER SC

MNCR53ER-BLK MB



Oval Cylinder Escutcheon

- Fixings included for back to back and face fixing
- For back to back fixing use with MNCR53B or MNCR53TS or MNCR53TSDA
- Screw on cover

MNCR53CE SC

MNCR53CE-BLK MB

Warranty information

3 YEAR WARRANTY

Products covered: Electronic entry and deadbolt. MN9000L, MN9000R, MN9001L and MN9001R.

All electrical and electronic components used in Miles Nelson range of products excluding batteries are guaranteed for a period of 3 years from the date of proof of purchase, unless otherwise stated.

Miles Nelson assumes no liability under the warranty for the following:

1. Improper installation or failure to follow fitting instructions.
2. Failure due to improper maintenance.
3. Fair wear and tear.
4. Indirect or consequential loss or damage.
5. Cost of removal and / or replacement.
6. Cost of freight and / or travelling time.
7. Damage to or deterioration of plated finishes (soft finishes) or finishes exposed to a corrosive environment. As deterioration is possible under some environmental conditions.
8. Any modification or repairs to a product, as supplied unless authorised by Miles Nelson.
9. Use of replacement parts other than authorised parts.
10. Malfunction or failure of the product due to the use of non-genuine Miles Nelson parts.

5 YEAR WARRANTY

Products covered: All General Hardware Products including Bannister Brackets, Bathroom Fittings, Cabinet Hardware & Handles, Cabin Hooks, Door Fittings, Door Stops, Hinges, Hooks, Kickplates, Push Plates, Grab Rails, Letterbox Letters & Numbers, Neck Bolts, Security Fittings (excluding the Patio Bolts, Mini Bolts, Restrictor Stays and Security Window Stays) and Socket Bolts.

These products are warranted to be free from mechanical and workmanship defects for 5 years from the original date of purchase.

If a mechanical defect occurs simply return the product together with proof of purchase to point of purchase for replacement.

Over time the surface may deteriorate if exposed to adverse atmospheric conditions caused by sea, air and weather. Finish deterioration caused by exposure to adverse atmospheric conditions or occurring from the use of paints, solvents, acid

cleaners or scratching from keys is not considered a defect in the finish and is not covered by the warranty conditions.

Likewise the warranty does not cover damage caused by incorrect installation, accident, neglect or other factors over which Miles Nelson have no control and as such Miles Nelson shall not be held liable for any losses or expenses such as loss of use, damage to property or consequential damages or expenses.

10 YEAR MILES NELSON WARRANTY

Products covered: Miles Nelson Commercial Door Furniture, Miles Nelson Commercial Door Closers, Door Handles & Pulls, Restrictor Stays, Security Window Stays, Patio Bolts and Mini Bolts.

These products are warranted to be free from workmanship defects for 10 years from the original date of purchase. If a defect is detected simply return the product together with proof of purchase to the supplier for replacement. Products are designed for interior residential applications, unless otherwise stated.

Over time the surface may deteriorate if exposed to adverse atmospheric conditions caused by sea, air and weather. Finish deterioration caused by exposure to adverse atmospheric conditions or occurring from the use of ammoniated detergents, metal polishes, solvents, corrosive environments or other abrasive agents or scratching from keys is not considered a defect in the finish and as such is not covered by the warranty.

Likewise, the warranty does not cover damage caused by incorrect installation, accident, neglect or other factors over which Miles Nelson have no control and as such Miles Nelson shall not be held liable for any losses or expenses such as loss of use, damage to property or consequential damages or expenses.

10 YEAR MECHANICAL WARRANTY

Products covered: S Range and Milano door handles.

These products are warranted to be free from mechanical and workmanship defects for 10 years from the original date of purchase. If a mechanical defect occurs simply return the product together with proof of purchase to point of purchase for replacement.

This warranty does not cover the finish, defects or damage arising from improper installation, incorrect product application, improper maintenance, storage, shipping, handling or normal wear and tear or products used in commercial applications as "Commercial" is defined as any application other than those found on private residences.

25 YEAR MECHANICAL WARRANTY

Miles Nelson Manufacturing Ltd guarantees its products against defects in workmanship and materials. Should the product develop fault within its normal working life, Miles Nelson will repair or replace product of the same or equivalent product free of charge. Miles Nelson Manufacturing Ltd assumes no liability under this guarantee for the following.

1. Incorrect installation or failure to follow instructions.
2. Failure through improper maintenance or fair wear and tear.
3. Loss or damage costs incurred either indirect or consequential.
4. Cost of removal, replacement, and/or travelling time.
5. Any modification to the product from its original supplied operation design.
6. Plated finishes deterioration under some climatic conditions or chemical environment are exempt from this guarantee.

Miles Nelson Manufacturing Ltd reserves the right to determine whether or not any fault is caused by defects in workmanship or that any product is defective. Product specification and design improvement may change as a result of our continued commitment to quality, materials and development program. Consumer Guarantees act does not apply.

CU

Copper Maintenance

While copper is extremely aesthetically pleasing, it also has an inherent ability to kill a wide range of harmful microbes relatively rapidly – often within two hours or less which makes it the perfect metal to use on a door with a lot of use. This plus its durability makes it perfectly suited to New Zealand's coastal environment and will last a lifetime. The natural tendency of the 100% hand finished pure copper is to show its perfect imperfections, a realness that will age organically over time. This ageing process can give a sense of life and history to the hardware.

Over time the surface may deteriorate if exposed to adverse atmospheric conditions caused by sea, air and weather. Finish deterioration caused by exposure to adverse atmospheric conditions or occurring from the use of paints, solvents, acid cleaners or scratching from keys is not considered a defect in the finish and is not covered by the warranty conditions.

However, if the "as new" look is desired, then maintenance with an approved cleaner will ensure the mirror finish will always be maintained.

Clean regularly using Brasso or something similar with a soft cloth or soft brush. Do not use abrasive cleaners or a scouring pad of any type as they may cause excessive wear and dull the finish.

B BRASS LIFETIME GUARANTEE

The lifetime warranty covers the integrity of the product(s) base material and as such the product is guaranteed to be free from material defects for the lifetime of the product.

The product finish is subject to the same conditions that apply to the 5 year warranty, as above.

304 QUALITY STAINLESS STEEL

316 MARINE GRADE STAINLESS STEEL

S QUALITY STAINLESS STEEL

There are two types of stainless steel commonly used in the hardware industry, 304 grade and 316 (marine) grade. 316 grade stainless has molybdenum as an additive that improves its resistance to pitting and corrosion and should be used when exposed to seaside conditions.

With a little bit of care you can minimise, if not prevent tea staining and get years of visual enjoyment from your stainless steel.

Tea staining can be described as: discolouration of the surface of stainless steel that does not affect the structural integrity or the longevity of the material. Tea staining of stainless steels occurs most commonly in coastal areas and becomes progressively worse the closer you get to water (note that most of New Zealand is considered a coastal area). Other factors such as pollution, higher temperatures and humidity can also increase the effect.

To prevent tea staining, perform regular maintenance – Wash regularly with clean fresh water, mild detergent and a cloth or soft brush. After washing rinse in clean water and wipe the surface dry with a soft absorbent cloth remembering to go with the grain on brushed stainless steel. Generally, you should wash your stainless steel every time you wash your windows or every three months. Do not use abrasive cleaners or a scouring pad of any type as they may cause excessive wear and dull the finish.



Miles Nelson[®]

Architectural Hardware est. 1928



To view the full range of products visit:
[milesnelson.co.nz](https://www.milesnelson.co.nz)

Follow us on:

-  **MilesNelsonNZ**
-  **MilesNelsonNZ**
-  **MilesNelsonNZ**

P: 0800 663 5766
F: +64 9 489 5552
E: info@milesnelson.co.nz
PO Box: 31 043 | Milford, Auckland