

Windsor

ARCHITECTURAL HARDWARE

It's the finer details that
make a home

Make yours with the
Windsor touch



No. 22

Product
Catalogue

windsorhardware.co.nz



Hand finished in New Zealand

Levers, roses and plates are forged and machined using the finest quality solid brass and arrive at Windsor in their raw state to be processed and hand-finished.

To create the different finishes, we use a variety of metal treatments, then the finish is relieved-back by hand by one of our specialist craftspeople, creating a series of natural finishes embellished with lustre, patina, tone and texture. This aspect of our work sets us apart as we are able to achieve bespoke finishes that are not possible through mass production.

Accessories and pull handles are batch processed with levers for colour coordination.

The living finishes are designed to age gracefully over time and are becoming increasingly popular in contemporary homes to complement materials such as rustic steel, schist, timber and concrete, as well as structural components, including exposed beams and visible fixings.

STANDARD STOCK FINISHES

The standard stock finishes range from the classic Brushed Nickel and Satin Chrome through to the trending Graphite Nickel and Matt Black. All stocked finishes offer a range of door and window accessories to complement your handle choice and have a coordinated look and feel throughout the home.

1-2 Day Lead Time

1-2 day delivery time applies to standard stocked products. In the unlikely event of delays or out of stocks, extended lead times will occur.



SPECIAL FINISHES

This collection of bespoke finishes are created using a variety of metal treatments, then the finish is relieved back by hand by one of our specialist craftspeople. Some finishes are left in their natural state to age gracefully over time, this is our living finish range, others are coated with a resin lacquer to protect the colour and provide either a high gloss or matt finish, these are our lacquered finishes. Accessories and pull handles are batch processed for colour coordination.

14 Day Lead Time

14 days delivery time applies to non-stocked bronze and powdercoated products and made to order pull/bar handles. Products and finishes in this category are non-returnable items. In the unlikely event of delays, extended lead times will occur.

- > Use MB where RLB is not available
- > To match MSB, use USB
- > When using AB, some accessories are Bronze PC to match
- > Use PVD to match PB where PB is not available
- > Please refer to specific product information for AB, PB, RLB and UB lead times. Some items have 1-2 days delivery times.

LIVING FINISHES



LACQUERED FINISHES



Terms & Conditions

- > Products, specifications, finishes and lead times are subject to change without notice
- > Special finishes on products may vary from colour swatches shown
- > A minimum quantity or extra surcharge may apply for some finishes
- > Special order products are non-returnable
- > Please check lead times for special orders
- > Brass items can be supplied unlacquered (surcharge applies)

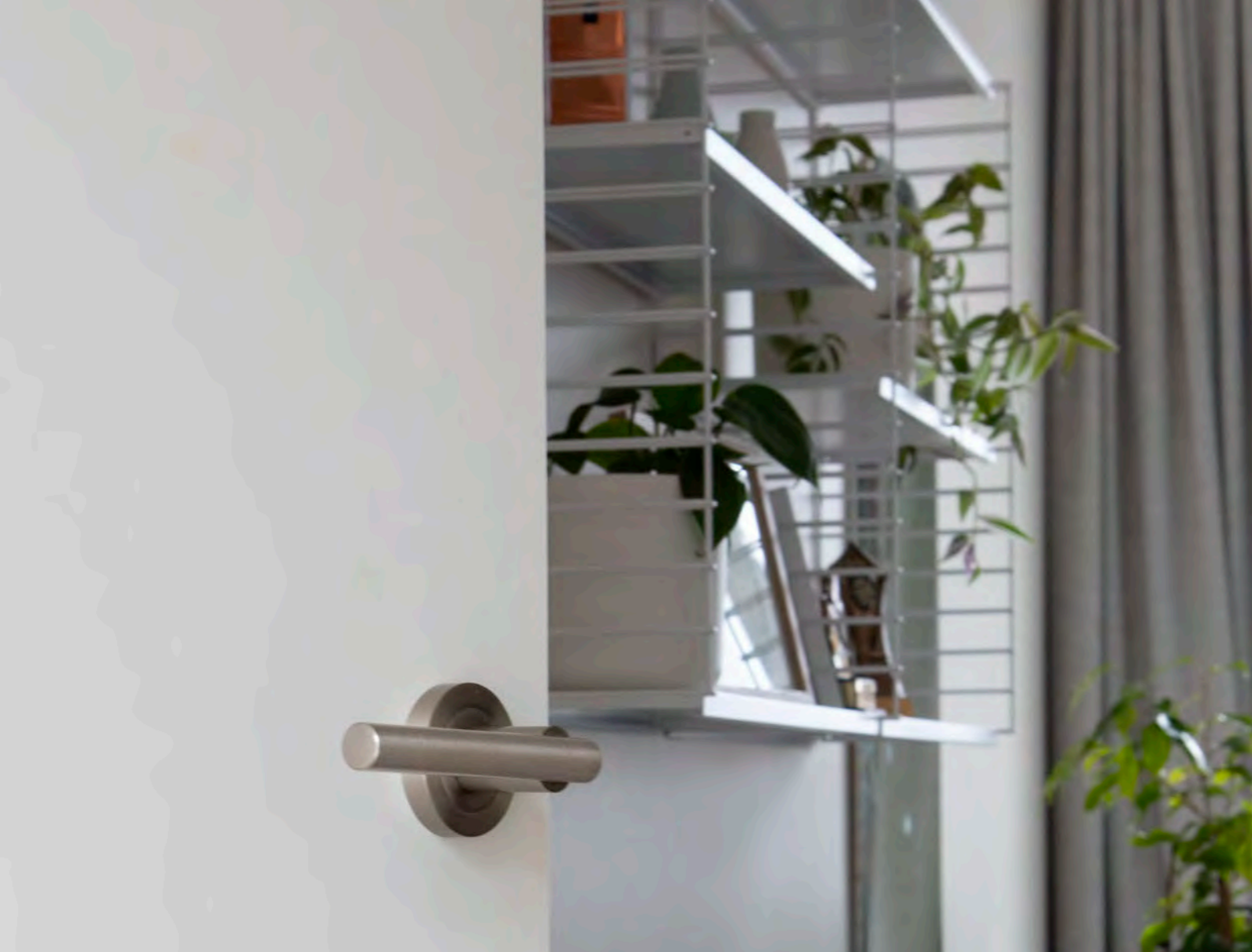

Insist on style and quality. Insist on Windsor.

Established in 1984 Windsor sought to go beyond what had already been mastered. What started as a vision, has today become a leading supplier in the New Zealand market as an award winning national architectural hardware company.

Our proven experience has led the Windsor name to be renowned for a commitment to continuous improvement enabling the company to remain progressive and stay ahead of market trends. But what always remains constant is our reputation for exceptional customer service and quality.

We are pleased to present in this catalogue innovative bespoke architectural hardware products that are elegant, functional, reliable and produced in a sustainable way.

Windsor's design approach follows three fundamental elements – feel, finish and function. The 'feel' correlates with the design, engineering and ergonomics of the handles; the 'finish' element is the visual aspect achieved at the intersection of colour, trends and natural patina, and the 'function' refers to the mechanism, installation and how it operates on the door.

We invite you to peruse the range, make your choice and compare the difference.

WINDSOR CONTENTS

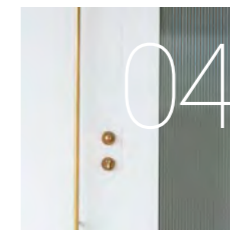

Entrance Pull Handles

316 Grade.....	06
304 Grade.....	09
Solid Brass.....	12
NZ Made.....	13
Entrance Lock Kits.....	14

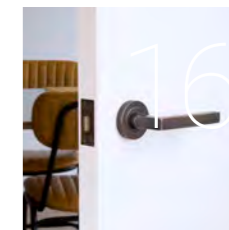

Door Furniture

Italian.....	16
NIDO.....	24
Traditional & Belmont.....	32
Architectural.....	36
Astron.....	40
Ellipse & Streamline.....	44
Galaxy.....	48
Futura.....	52
Halo.....	56
Jura & Contract.....	60

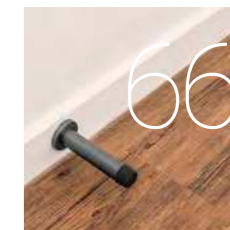

Door Accessories

Doorstops.....	68
Magnets.....	70
Barrel Bolts.....	71
Escutcheons.....	73

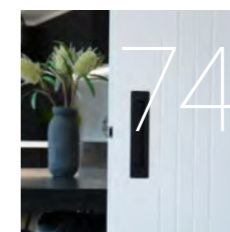

Privacy & Sliding Door

Turns & Mini Levers.....	76
Privacy Sets.....	77
Cavity Suites.....	79
Flush Pulls.....	80



Window Fittings, Hooks & Bannister Brackets

Window Fittings.....	84
Hooks.....	86
Bannister Brackets.....	87



Cabinet Handles

Lifestyle & Designer.....	90
Knobs.....	93



Door Closers

Light to Heavy Duty.....	94
Cam Action & Drop Plates..	97
ARLU Invisible Hinges.....	98

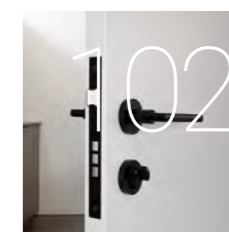

Locks, Latches & Cylinders

Tubular Latches.....	104
Privacy Bolts.....	105
Latch Sets.....	106
Euro Profile Cylinders.....	107

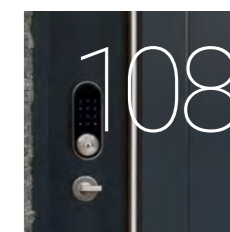

Keyless Entry

Bluetooth Deadbolt Locks...	108
-----------------------------	-----



Care, Maintenance & Technical

Finishes Care.....	110
Rebate Kits.....	112
Exploded Views.....	114

Abbreviations

Ø	Diameter
id	Inside Diameter
od	Outside Diameter

o/a	Overall Length
pic	As Pictured
b/s	Backset

c/s	Case Size
pj	Projection
crs	Screw/Bolt Centres



Square Profile Pull Handle - 1800mm
Stainless Steel
Square Double Turn Lock Kit
Brushed Nickel



Square Profile Pull Handle - 450mm
Graphite Nickel

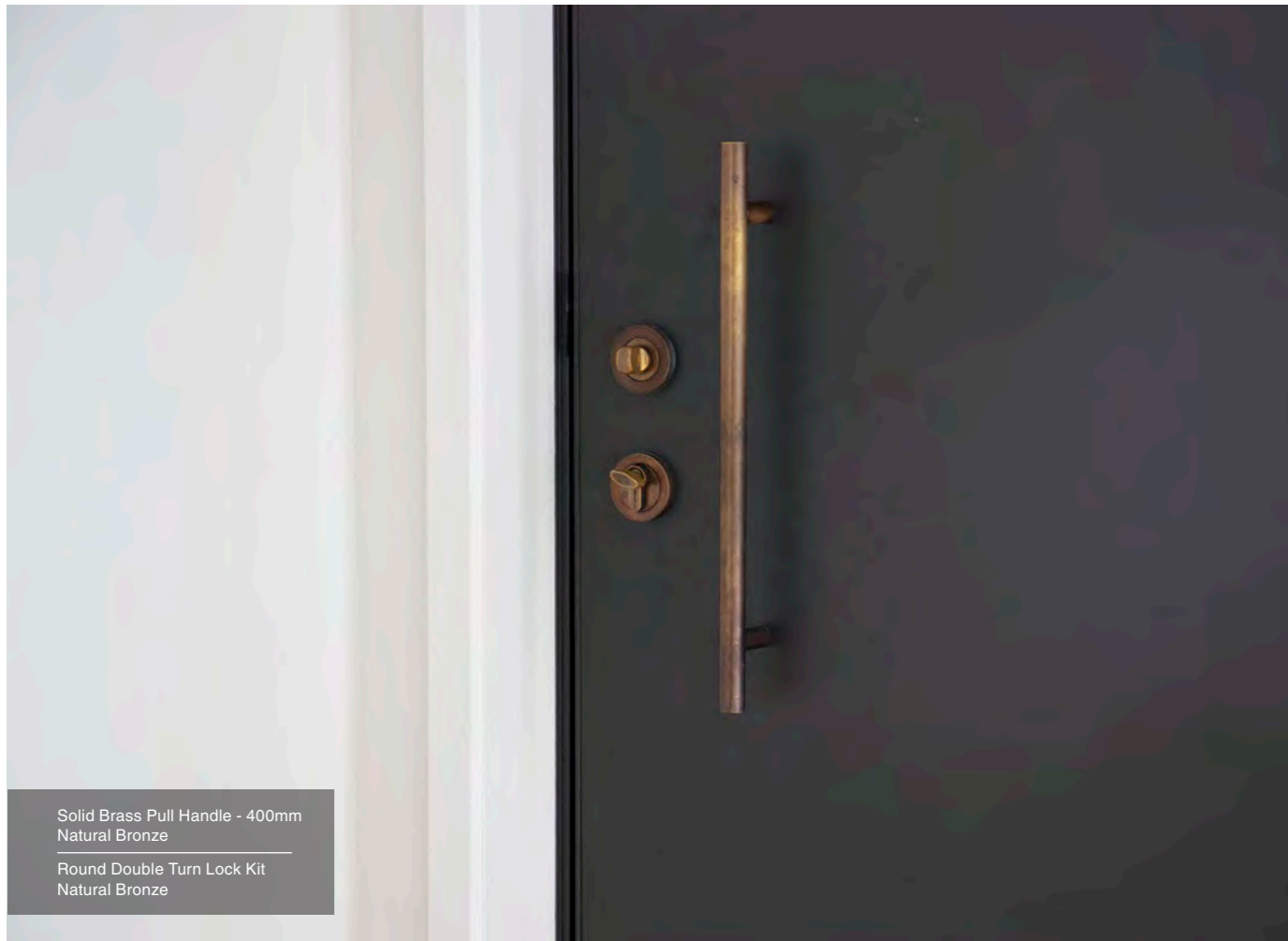

Solid Brass Pull Handle - 400mm
Natural Bronze
Round Double Turn Lock Kit
Natural Bronze



Entrance Pull Handles & Lock Kits

Solid Brass Pull Handle - Custom Length
Unlacquered Brass
Round Double Turn Lock Kit
Unlacquered Brass



Streamline

code	mm crs	mm o/a	mm bar	mm pj
7238	275	300	25 x 13	50
7239	420	450	30 x 15	58
7240	570	600	30 x 15	58
7241	870	900	30 x 15	58

1374 DT Combo*
1373 ML Combo**

Finishes:
BLK SS PC



Marco

code	mm crs	mm o/a	mm bar	mm pj
7187	260	300	20 x 10	50
7188	400	450	25 x 13	60
7189	550	600	25 x 13	60
7190	850	900	25 x 13	60

1326 DT Combo*
1367 ML Combo**

Finishes:
BLK SS PC



Polo

code	mm crs	mm o/a	mm bar	mm pj
7098	270	300	30 x 15	50
7099	410	450	40 x 20	60
7100	560	600	40 x 20	60
7101	860	900	40 x 20	60
7102	1160	1200	40 x 20	60

(7102 only available in SS & PC)

1221 DT Combo*
1366 ML Combo**

Finishes:
BLK GN SS PC



Square Profile

code	mm crs	mm o/a	mm bar	mm pj
7066	200	300	20 x 20	50
7054	276	450	25 x 25	68
7055	426	600	25 x 25	68
7095	726	900	25 x 25	68
7096	1026	1200	25 x 25	68
7097	1626	1800	25 x 25	68

(GN plating only available in 7066, 7054 & 7055)

1231 DT Combo*
1371 ML Combo**

> Can be customised to any length up to 3600mm

Finishes:
BLK GN SS PC

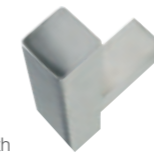

Round Profile

code	mm crs	mm o/a	mm bar	mm pj
7025	250	450	32	78
7026	400	600	32	78
7092	700	900	32	78
7093	1000	1200	32	78
7094	1600	1800	32	78

1232 DT Combo*
1370 ML Combo**

> Can be customised to any length up to 3600mm

Finishes:
BLK SS PC



Double Turn Combo Kit



Includes:

- > 1 Pair of 600mm Pull Handles
- > 1183 or 1184 Double Turn Lock Kit
- > 5264 60mm Floor Mount Doorstop

Mini Lever Combo Kit



Includes:

- > 1 Pair of 600mm Pull Handles
- > 1364 or 1365 Mini Lever Lock Kit
- > 5264 60mm Floor Mount Doorstop

Sold as back to back pairs but also available as singles with face fix or rear thru-fix door fixing.

Sold as back to back pairs but also available as singles with face fix or rear thru-fix door fixing. Custom lengths lead time 14–28 days.

* **DT Combo:** Double Turn Combo Kits include 1 Pair of 600mm Pull Handles, 1183 or 1184 Double Turn Lock Kit & 5264 60mm Floor Mount Doorstop.

** **ML Combo:** Mini Lever Combo Kits include 1 Pair of 600mm Pull Handles, 1364 or 1365 Mini Lever Lock Kit & 5264 60mm Floor Mount Doorstop.

* **DT Combo:** Double Turn Combo Kits include 1 Pair of 600mm Pull Handles, 1183 or 1184 Double Turn Lock Kit & 5264 60mm Floor Mount Doorstop.

** **ML Combo:** Mini Lever Combo Kits include 1 Pair of 600mm Pull Handles, 1364 or 1365 Mini Lever Lock Kit & 5264 60mm Floor Mount Doorstop.

ENTRANCE PULL HANDLES

316 GRADE STAINLESS STEEL & OFFSET 316 GRADE STAINLESS STEEL

STAINLESS STEEL



Round Profile Solid Bar

Square Profile

Round Profile

Round Profile

Nitro

Curved Nitro

code	mm crs	mm o/a	mm bar	mm pj
7119 Straight	200	300	19	52
7159 Offset	200	300	19	52
7120 Straight	350	450	19	52
7160 Offset	350	450	19	52
7121 Straight	500	600	19	52
7161 Offset	500	600	19	52
7122 Straight	800	900	19	52
7162 Offset	800	900	19	52
7123 Straight	1100	1200	19	52
7163 Offset	1100	1200	19	52
7124 Straight		Any length to 3600mm		52
7164 Offset				52

code	mm crs	mm o/a	mm bar	offset	mm pj
7064	276	450	25x25	25	65
7065	426	600	25x25	25	65
7145	726	900	25x25	25	65
7146	1026	1200	25x25	25	65
7147	1626	1800	25x25	25	65

> Can be customised to any length up to 3600mm

Finishes:

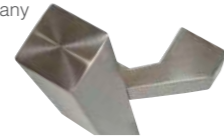

code	mm crs	mm o/a	mm bar	offset	mm pj
7027	250	450	32	25	50
7028	400	600	32	25	70
7142	700	900	32	25	70
7143	1000	1200	32	25	70
7144	1600	1800	32	25	70

> Can be customised to any length up to 3600mm

Finishes:



Finishes:



code	mm crs	mm o/a	mm bar	offset	mm pj
7181	425	450	32	55	81

> Only available in 304 Grade Stainless Steel

Finishes:



code	mm crs	mm o/a	mm bar	offset	mm pj
7128	280	300	20x20	30	50
7129	425	450	25x25	35	60
7130	575	600	25x25	35	60
7131	875	900	25x25	35	60

1238 DT Combo*
1369 ML Combo**

> Only available in 304 Grade Stainless Steel

Finishes:



code	mm crs	mm o/a	mm bar	offset	mm pj
7182	425	450	25x25	78	60
7183	575	600	25x25	85	60

> Only available in 304 Grade Stainless Steel

Finishes:



Sold as back to back pairs but also available as singles with face fix or rear thru-fix door fixing. Custom lengths lead time 14–28 days.

Sold as back to back pairs but also available as singles with face fix or rear thru-fix door fixing.

* **DT Combo:** Double Turn Combo Kits include 1 Pair Pull Handles, 1183 or 1184 Double Turn Lock Kit & 5264 60mm Floor Mount Doorstop.

** **ML Combo:** Mini Lever Combo Kits include 1 Pair Pull Handles, 1364 or 1365 Mini Lever Lock Kit & 5264 60mm Floor Mount Doorstop.

* **DT Combo:** Double Turn Combo Kits include 1 Pair Pull Handles, 1183 or 1184 Double Turn Lock Kit & 5264 60mm Floor Mount Doorstop.

** **ML Combo:** Mini Lever Combo Kits include 1 Pair Pull Handles, 1364 or 1365 Mini Lever Lock Kit & 5264 60mm Floor Mount Doorstop.



Locking Pull Handle

code	mm crs	mm o/a	mm bar	mm pj
7154	1100	1500	35	85

SP7154 Keyed alike barrel for 7154
1287 Key blanks to suit 7154

- > Includes five keys and dust socket
- > Suitable for glass doors 10–16mm thick
- > Only available in 304 Grade Stainless Steel



Finishes:
SS PC

Torch

code	mm crs	mm o/a	mm bar	mm pj
7103	160	350	32	75
7104	250	530	38	80

1273 DT Combo*
1368 ML Combo**
DT and ML Combos are only available for 7104

- > Only available in 304 Grade Stainless Steel

Finishes:
BLK SS PC



Snake

code	mm crs	mm o/a	mm bar	mm pj
7134	300	600	38	70

1239 DT Combo*
> Only available in 304 Grade Stainless Steel

Finishes:
SS PC

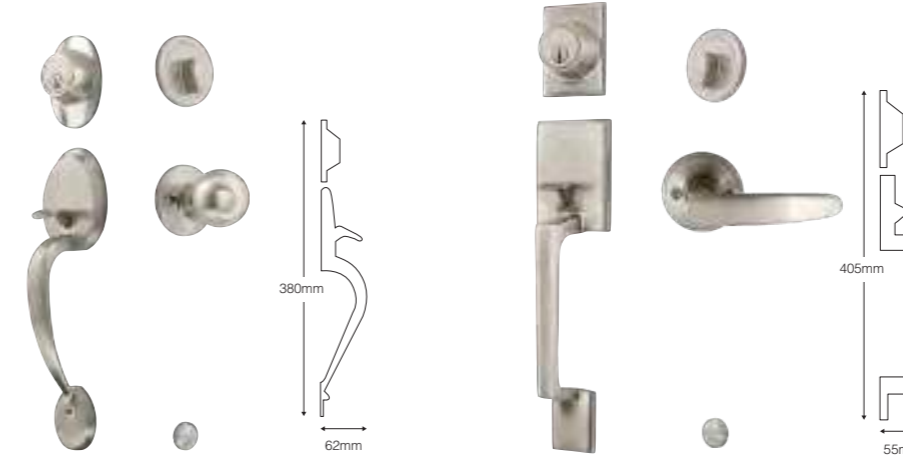

Oval Gripset

9046 Oval Solid Brass Gripset with Rear Knob (pic)
9046CL Oval Solid Brass Gripset with Rear Lever

Finishes:
BN PC

Square Gripset

9047 Square Solid Brass Gripset with Rear Knob
9047CL Square Solid Brass Gripset with Rear Lever (pic)

Finishes:
BN PC

Gripsets

- Include:
- > Exterior handle and lock plates are solid brass
 - > Auxiliary Deadbolt
 - > 60mm–70mm adjustable backset
 - > 25mm bolt throw
 - > Suits doors 38mm–50mm thick
 - > C4 key profile



Pull Handles on Plate

7184 Heavy Duty Solid Pull 16mm x 250mm D-Pull 300mm x 100mm plate
7165 Tubular Pull
7168 Heavy Duty Solid Pull 300mm x 65mm plate
> Can be used back to back with 7185 - thru-fixing

Finishes:
SS PC

Push Plates

7185 300mm x 100mm plate
> Concealed fixings
> Can be used back to back with 7184 - thru-fixing
7166 300mm x 65mm plate
7167 300mm x 100mm plate

Finishes:
SS PC

Black Iron

2025 Pull Handle (Single) 265mm o/a

Finishes:
BLK

Sold as back to back pairs but also available as singles with face fix or rear thru-fix door fixing.

* **DT Combo:** Double Turn Combo Kits include 1 Pair Pull Handles, 1183 or 1184 Double Turn Lock Kit & 5264 60mm Floor Mount Doorstop.

** **ML Combo:** Mini Lever Combo Kits include 1 Pair Pull Handles, 1364 or 1365 Mini Lever Lock Kit & 5264 60mm Floor Mount Doorstop.

ENTRANCE PULL HANDLES

SOLID BRASS

NZ MADE ARTISAN

The NZ Made Artisan collection of pull handles are made from solid brass, machined in New Zealand by kiwi craftsmen then finished by hand.

Named after some of New Zealand's great walks, these handles will provide a vista for your front door or connecting rooms similar to towering trees in native landscapes.

These styles can also be custom made to any length up to 800mm for all finishes. For lengths above 800mm please enquire for available finish options.

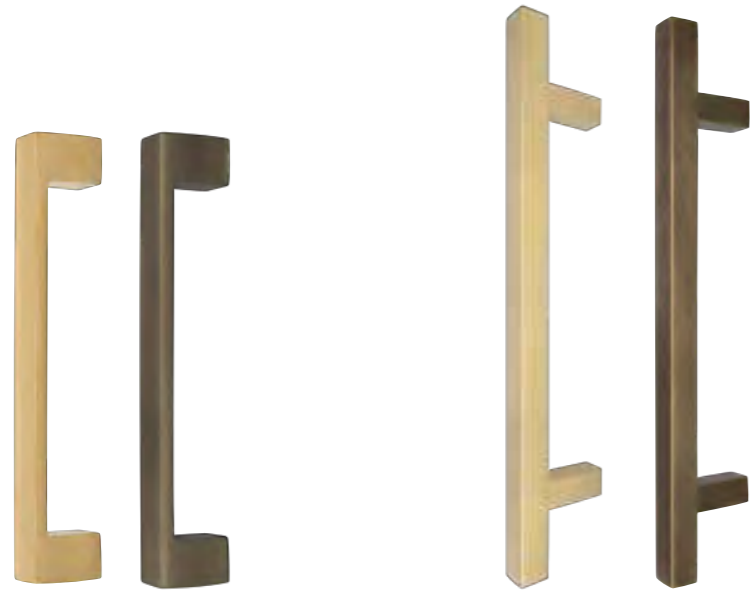

Square Profile

code	mm crs	mm o/a	mm bar	mm pj
8193	210	235	25 x 25	42

Shown in UB and RB
> 8193 not available as custom length, if required refer to 8342 style



Round Profile

code	mm crs	mm o/a	mm bar	mm pj
8192	210	300	17 x 17	53
8190	210	300	19	52
8191	300	400	19	52

Shown in UB and DRB



Milford

code	mm crs	mm o/a	mm bar	mm pj
8331	340	400	25	65
8332	540	600	25	65

Shown in PB and DRB

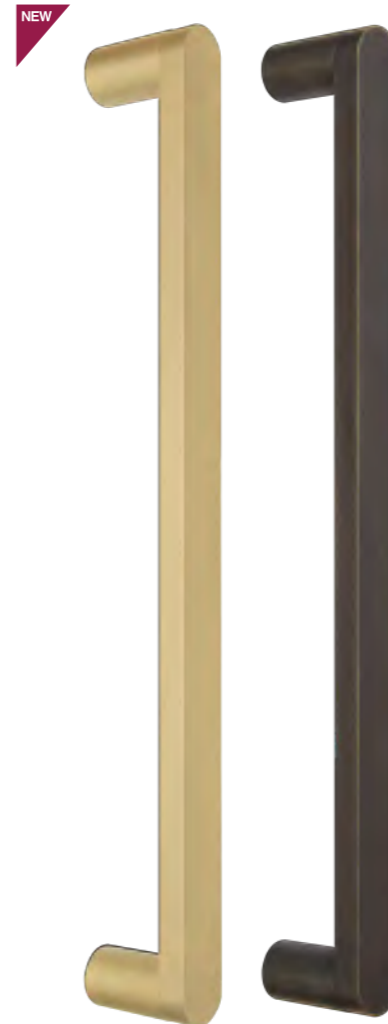

Kepler

code	mm crs	mm o/a	mm bar	mm pj
8336	375	400	25 x 12	53
8337	575	600	25 x 12	53

Shown in MB and DRB

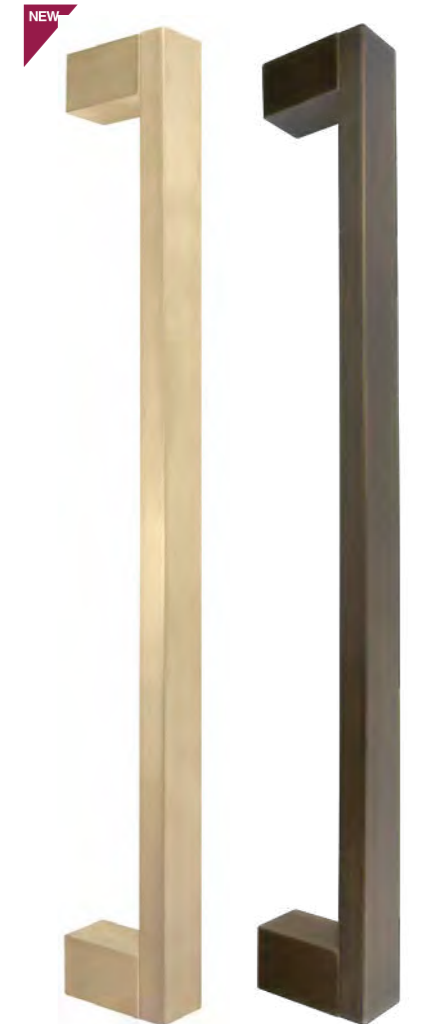

Tasman

code	mm crs	mm o/a	mm bar	mm pj
8341	375	400	25 x 12	53
8342	575	600	25 x 12	53

Shown in USB and BHB



Sold as back to back pairs. Custom lengths available as face fixed and rear fixed singles. Custom lengths lead time 14 – 28 days.

Recommend pairing with 1183 Pull Handle Double Turn Lock Round 60mm

Sold as back to back pairs but also available as singles with face fix or rear thru-fix door fixing. Custom lengths lead time 14 – 28 days.

Recommend pairing with 1183 Pull Handle Double Turn Lock Round 60mm



Double Turn Lock Kits

1182
50mm Ø roses
57mm backset

Finishes:

1183
54mm Ø roses
60mm backset

- > Available as 10mm short throw
- > Available as 18mm standard throw
- > Brass and bronze finishes only available in 50mm Ø roses

Finishes:

1184
54mm square roses
60mm backset

- > Available as 10mm short throw
- > Available as 18mm standard throw

Finishes:



Double Turn Lock Kits

1258
60mm x 30mm roses
60mm backset

Finishes:

1259
60mm x 30mm roses
35mm backset

Finishes:



Uni-Turn Lock Kits

1248
54mm Ø roses
60mm backset

- > Single turn design to eliminate chance of binding
- > Save time on installation, with square drive fixing screws suited to aluminium joinery industry
- > Brass and bronze finishes only available in 50mm Ø roses

Finishes:

1249
54mm square roses
60mm backset

Finishes:

1250 (pic)
60mm x 30mm roses
60mm backset

Finishes:

1251
60mm x 30mm roses
35mm backset



Mini Lever Lock Kits

1364
54mm Ø roses
60mm backset

- > Designed with large flat surface area on side of turn making it simpler and easier to use
- > Thru-fixing for easy alignment on the door, preventing binding

Finishes:

1365
54mm square roses
60mm backset

Finishes:



Haven Longplate - Lever Set
Dark Roman Brass



Chalet Rose - Privacy Set
Satin Brass

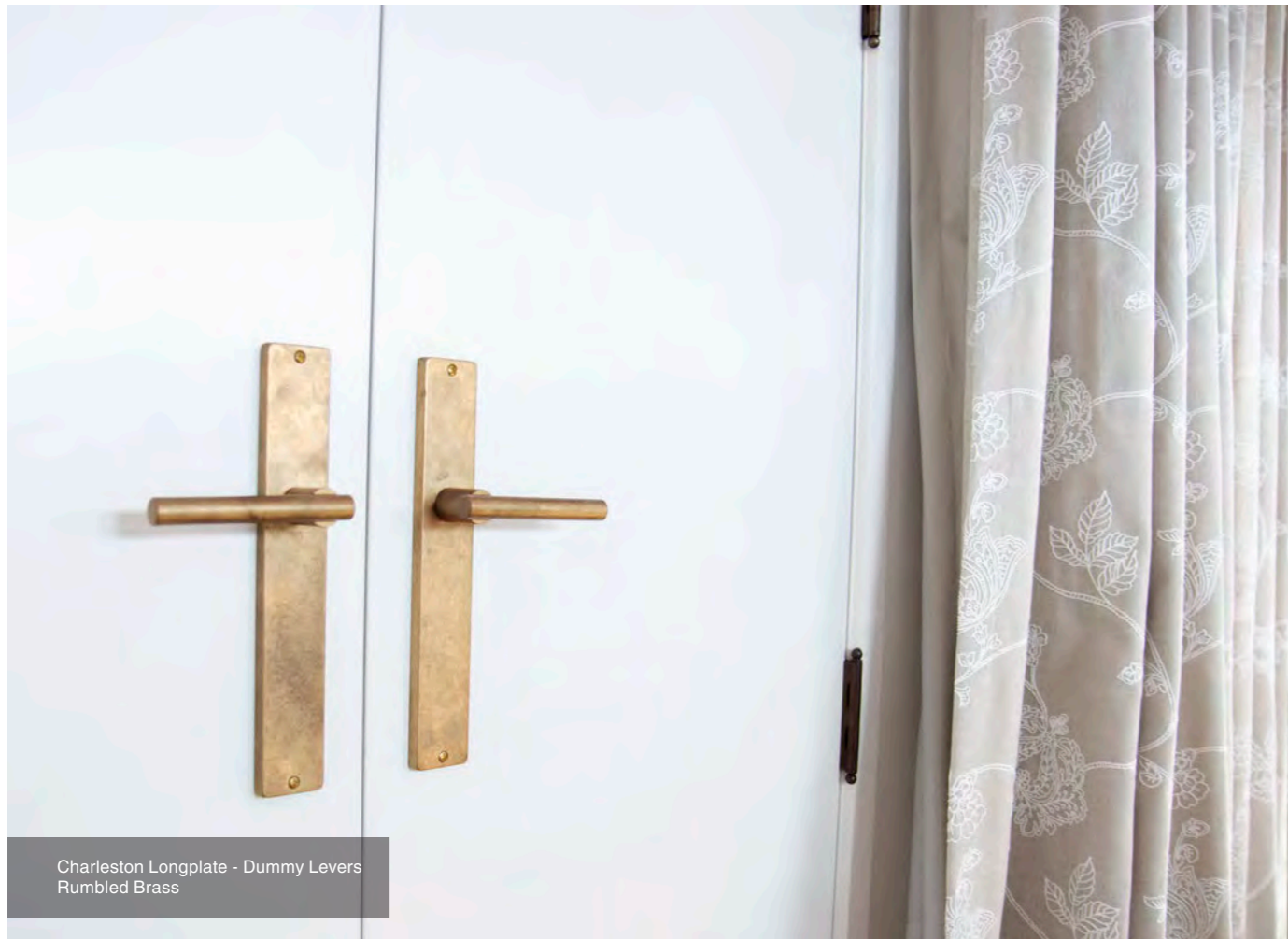

Charleston Longplate - Dummy Levers
Rumbled Brass



DOOR FURNITURE

Italian



Federal Rose - Passage Set
Oil Rubbed Bronze

The Italian range includes six luxurious collections which are all available in 15 different finishes, allowing the perfect coordination with the overall aesthetics of a home.

- > **Passage Set**
Includes Levers and 1172 Tubular Latch
- > **Privacy Set**
Includes Levers, 1172 Tubular Latch, 1173 Privacy Bolt and 8188 Privacy Turn & Release Set
- > **Entrance Set E85**
Includes Levers, 1143 Euro 85 Lock, 1148 Cylinder and 8189 Euro Escutcheons
- > **Longplate Passage Set**
Includes Longplates and 1172 Tubular Latch
- > **Longplate Privacy Set**
Includes Priv-85 Longplates, 1172 Tubular Latch, 1173 Privacy Bolt and 8055 Privacy Turn & Release
- > **Longplate Entrance Set E48**
Includes E48 Longplates, 1115 Euro 48 Lock and 1148 Cylinder
- > **Longplate Entrance Set E85**
Includes E85 Longplates, 1143 Euro 85 Lock and 1148 Cylinder

Federal

The solid surfaces of the lever join the rose or longplate with contoured detailing. Pronounced accents make a bold statement that confidently blends colonial and Italian style.



Small Rose

- | | |
|------------------------------|-------------------------|
| 8221 Lever Set | 8222 Passage Set |
| 8221D Dummy Lever | 8227 Privacy Set |
| 52mm Ø rose
Shown in PB | |
| 8229 E85 Entrance Set | |



Large Rose

- | |
|---|
| 8226 Lever Set |
| 64mm Ø rose
Shown in USB |
| > Large rose option ideal for retro-fit |



Square Longplate

- | | |
|--------------------------------|------------------------------|
| 8225 Blank (pic) | 8225-E48 Euro Keyhole |
| 8225L Standard Keyhole | 8225-E85 Euro Keyhole |
| 8225LD Dummy Lever - LH | 8275 Passage Set |
| 8225RD Dummy Lever - RH | 8276 Privacy Set |
| | 8277 E48 Entrance Set |
| | 8288 E85 Entrance Set |

265mm x 42mm x 10mm plate
Shown in DRB

Charleston

The intersecting cylindrical shapes evoke balance and harmony. Inspired by industrial detailing of metropolitan construction, a modern and sophisticated aspect makes a confident statement.



Small Rose

- | | |
|------------------------------|-------------------------|
| 8201 Lever Set | 8202 Passage Set |
| 8201D Dummy Lever | 8207 Privacy Set |
| 52mm Ø rose
Shown in OR | |
| 8209 E85 Entrance Set | |



Large Rose

- | |
|---|
| 8206 Lever Set |
| 64mm Ø rose
Shown in RB |
| > Large rose option ideal for retro-fit |

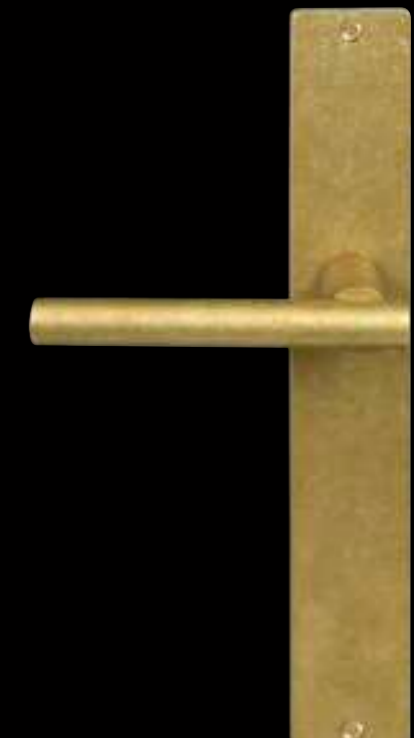

Square Longplate

- | | |
|--------------------------------|------------------------------|
| 8205 Blank (pic) | 8205-E48 Euro Keyhole |
| 8205L Standard Keyhole | 8205-E85 Euro Keyhole |
| 8205LD Dummy Lever - LH | 8271 Passage Set |
| 8205RD Dummy Lever - RH | 8272 Privacy Set |
| | 8273 E48 Entrance Set |
| | 8274 E85 Entrance Set |

265mm x 42mm x 10mm plate
Shown in RLB

Finishes:



Finishes:

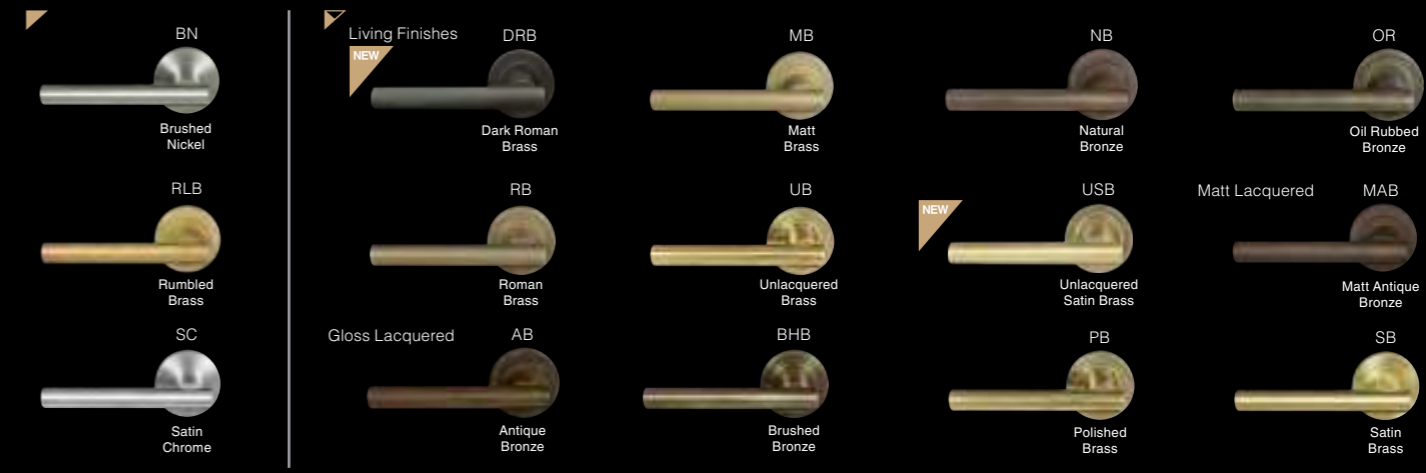

Chalet

Crisp and clean lines, with a distinctively European feel. An effortlessly stylish and slim design with radiused edges where smart and smooth look is desired.

- > **Passage Set**
Includes Levers and 1172 Tubular Latch
- > **Privacy Set**
Includes Levers, 1172 Tubular Latch, 1173 Privacy Bolt and 8188 Privacy Turn & Release Set
- > **Entrance Set E85**
Includes Levers, 1143 Euro 85 Lock, 1148 Cylinder and 8189 Euro Escutcheons
- > **Longplate Passage Set**
Includes Longplates and 1172 Tubular Latch
- > **Longplate Privacy Set**
Includes Priv-85 Longplates, 1172 Tubular Latch, 1173 Privacy Bolt and 8055 Privacy Turn & Release
- > **Longplate Entrance Set E48**
Includes E48 Longplates, 1115 Euro 48 Lock and 1148 Cylinder
- > **Longplate Entrance Set E85**
Includes E85 Longplates, 1143 Euro 85 Lock and 1148 Cylinder



Small Rose

- 8211** Lever Set
- 8212** Passage Set
- 8211D** Dummy Lever
- 8217** Privacy Set
- 8219** E85 Entrance Set

52mm Ø rose
Shown in SC



Large Rose

- 8216** Lever Set

64mm Ø rose
Shown in RLB

> Large rose option ideal for retro-fit



Square Longplate

- 8215** Blank (pic)
- 8215L** Standard Keyhole
- 8215LD** Dummy Lever - LH
- 8215RD** Dummy Lever - RH
- 8215-E48** Euro Keyhole
- 8215-E85** Euro Keyhole
- 8297** Passage Set
- 8298** Privacy Set
- 8299** E48 Entrance Set
- 8300** E85 Entrance Set

265mm x 42mm x 10mm plate
Shown in USB

Villa

The traditional markings are responsive to our cultural and architectural heritage, and combine perfectly with native timber.



Small Rose

- 8231** Lever Set
- 8232** Passage Set
- 8231D** Dummy Lever
- 8237** Privacy Set
- 8239** E85 Entrance Set

52mm Ø rose
Shown in MB



Large Rose

- 8236** Lever Set

64mm Ø rose
Shown in NB

> Large rose option ideal for retro-fit



Oval Longplate

- 8233** Blank (pic)
- 8233L** Standard Keyhole
- 8233LD** Dummy Lever - LH
- 8233RD** Dummy Lever - RH
- 8233-E48** Euro Keyhole
- 8233-E85** Euro Keyhole
- 8289** Passage Set
- 8290** Privacy Set
- 8291** E48 Entrance Set
- 8292** E85 Entrance Set

255mm x 42mm x 10mm plate
Shown in SB



Traditional Longplate

- 8234** Blank (pic)
- 8234L** Standard Keyhole
- 8234LD** Dummy Lever - LH
- 8234RD** Dummy Lever - RH
- 8234-E48** Euro Keyhole
- 8234-E85** Euro Keyhole
- 8293** Passage Set
- 8294** Privacy Set
- 8295** E48 Entrance Set
- 8296** E85 Entrance Set

255mm x 50mm x 10mm plate
Shown in RB

Finishes:

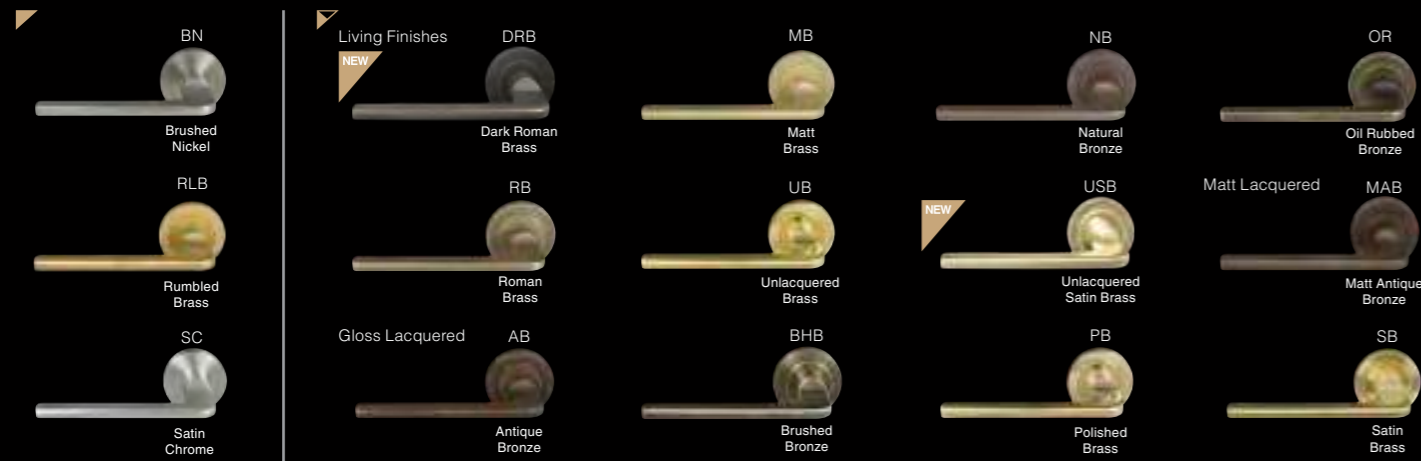

Finishes:

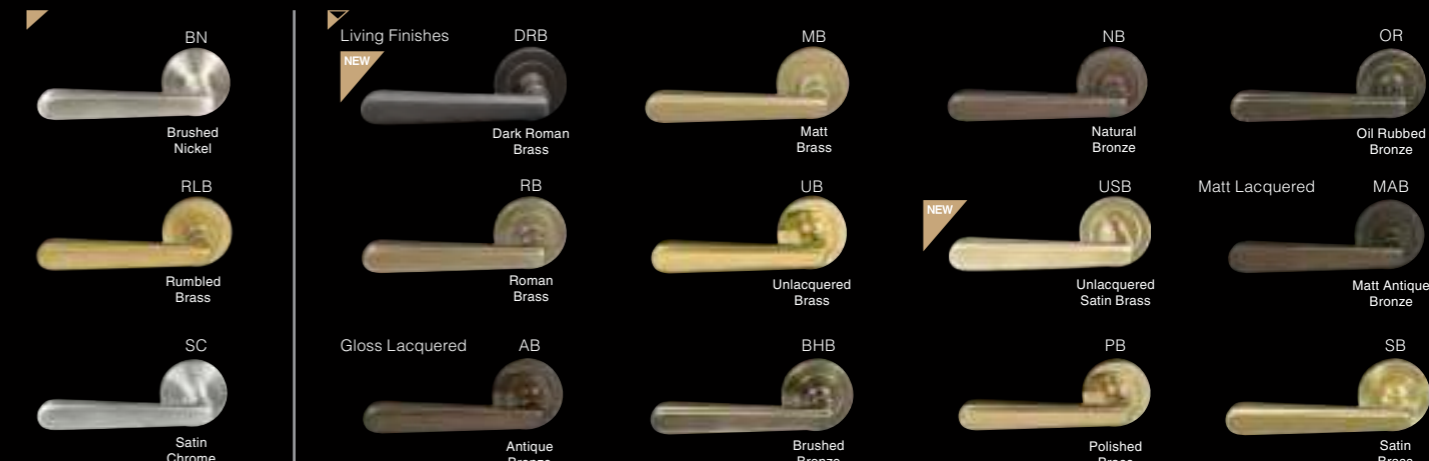

Haven

Classic elegance meets modern aesthetics expressed by a graceful curvature that follows the contour of your hand. Reminiscent of a wing, the changing shapes forge a luminous glow.



Small Rose

- 8167 Lever Set
- 8167LD Dummy Lever - LH
- 8167RD Dummy Lever - RH
- 8240 Passage Set
- 8241 Privacy Set
- 8243 E85 Entrance Set

52mm Ø rose
Shown in RB



Large Rose

- 8196 Lever Set

64mm Ø rose
Shown in RLB

> Large rose option ideal for retro-fit



Square Longplate

- 8194 Blank (pic)
- 8194L Standard Keyhole
- 8194LD Dummy Lever - LH
- 8194RD Dummy Lever - RH
- 8194-E48 Euro Keyhole
- 8194-E85 Euro Keyhole
- 8244 Passage Set
- 8245 Privacy Set
- 8246 E48 Entrance Set
- 8247 E85 Entrance Set

265mm x 42mm x 10mm plate
Shown in DRB



Oval Longplate

- 8168 Blank (pic)
- 8168L Standard Keyhole
- 8168LD Dummy Lever - LH
- 8168RD Dummy Lever - RH
- 8168-E48 Euro Keyhole
- 8168-E85 Euro Keyhole
- 8248 Passage Set
- 8249 Privacy Set
- 8250 E48 Entrance Set
- 8251 E85 Entrance Set

255mm x 42mm x 10mm plate
Shown in BHB



Traditional Longplate

- 8169 Blank (pic)
- 8169L Standard Keyhole
- 8169LD Dummy Lever - LH
- 8169RD Dummy Lever - RH
- 8169-E48 Euro Keyhole
- 8169-E85 Euro Keyhole
- 8252 Passage Set
- 8253 Privacy Set
- 8254 E48 Entrance Set
- 8255 E85 Entrance Set

255mm x 50mm x 10mm plate
Shown in SC

Finishes:



Hermitage

Radiant and striking, the Hermitage is furnished to inspire. Characterised by refined artistic shapes, the sculptural forms add glamorous and dramatic personality to your interior.



Small Rose

- 8170 Lever Set
- 8170LD Dummy Lever - LH
- 8170RD Dummy Lever - RH
- 8256 Passage Set
- 8257 Privacy Set
- 8259 E85 Entrance Set

52mm Ø rose
Shown in MAB



Large Rose

- 8197 Lever Set

64mm Ø rose
Shown in RLB

> Large rose option ideal for retro-fit



Square Longplate

- 8195 Blank (pic)
- 8195L Standard Keyhole
- 8195LD Dummy Lever - LH
- 8195RD Dummy Lever - RH
- 8195-E48 Euro Keyhole
- 8195-E85 Euro Keyhole
- 8260 Passage Set
- 8261 Privacy Set
- 8262 E48 Entrance Set
- 8263 E85 Entrance Set

265mm x 42mm x 10mm plate
Shown in AB



Oval Longplate

- 8171 Blank (pic)
- 8171L Standard Keyhole
- 8171LD Dummy Lever - LH
- 8171RD Dummy Lever - RH
- 8171-E48 Euro Keyhole
- 8171-E85 Euro Keyhole
- 8264 Passage Set
- 8265 Privacy Set
- 8266 E48 Entrance Set
- 8267 E85 Entrance Set

255mm x 42mm x 10mm plate
Shown in MB



Traditional Longplate

- 8172 Blank (pic)
- 8172L Standard Keyhole
- 8172LD Dummy Lever - LH
- 8172RD Dummy Lever - RH
- 8172-E48 Euro Keyhole
- 8172-E85 Euro Keyhole
- 8268 Passage Set
- 8269 Privacy Set
- 8270 E48 Entrance Set
- 8230 E85 Entrance Set

255mm x 50mm x 10mm plate
Shown in USB

Finishes:



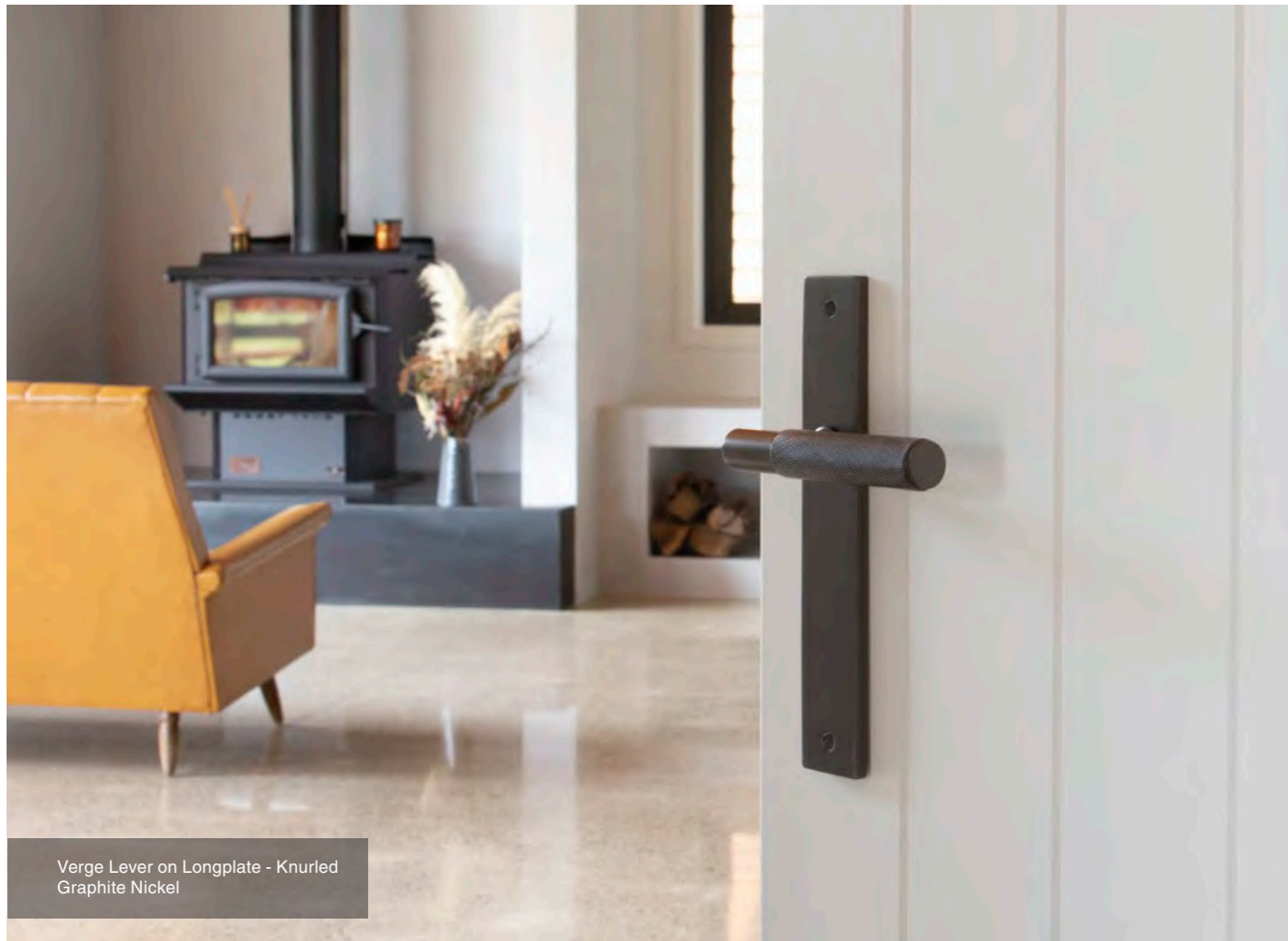

Verge Lever on Longplate - Knurled Graphite Nickel

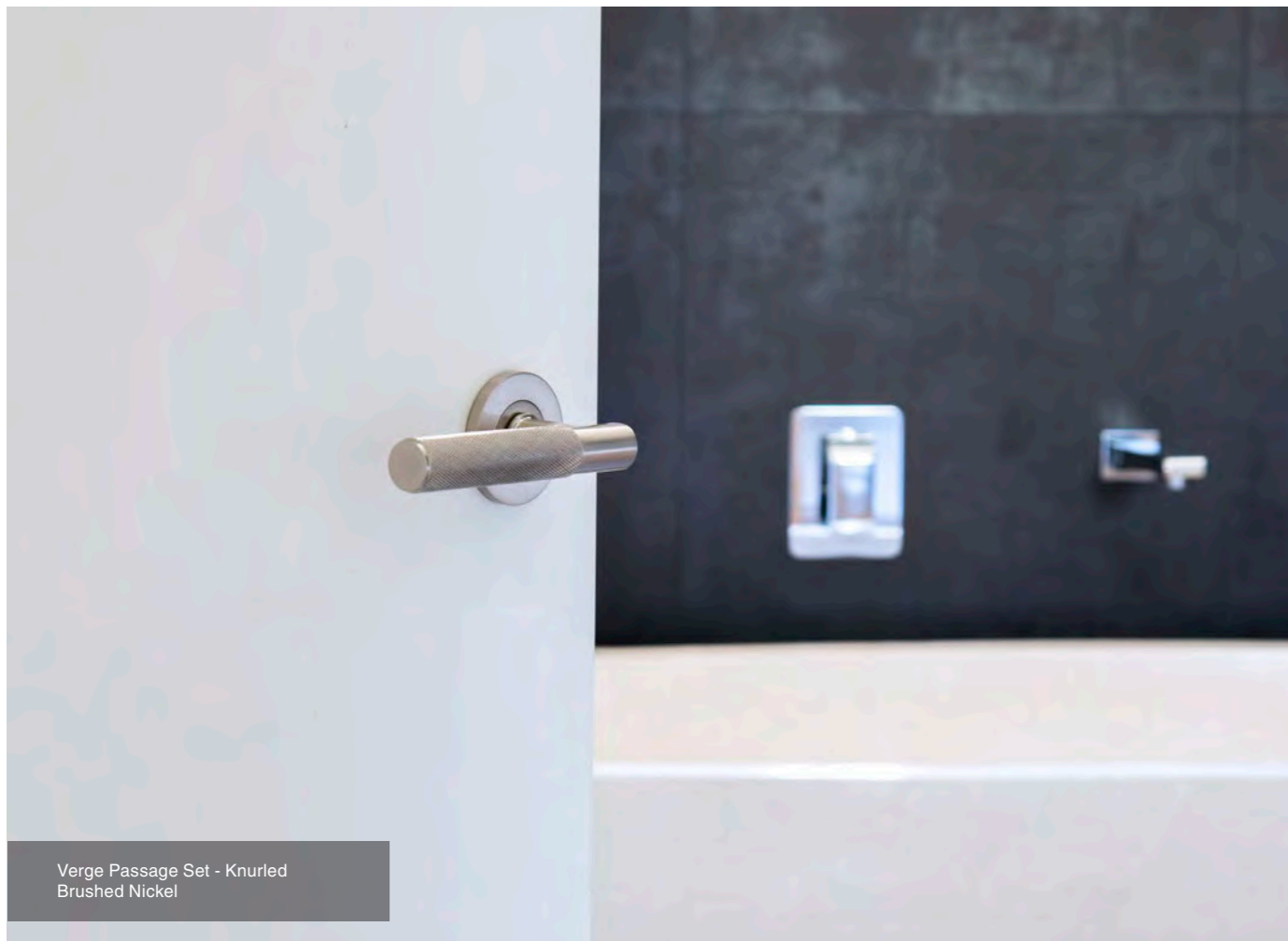

Verge Passage Set - Knurled Brushed Nickel



NEW

DOOR FURNITURE

NIDO



Modella Privacy Set
Matt Black

A diamond in the rough.

Sleek edges embellished with raw texture offer a sensory experience.

Simplicity and complexity unite in a harmonious fusion.

A natural evolution of industrial elegance.

Lumina

The juxtaposition of modern vs. timeworn makes for a layered and textured statement. Bold hues are saved for the small details with the diamond knurling embellishing.



Rose

- 8411 Lever Set - Knurled
 - 8411D Dummy Lever - Knurled
 - 8412 Passage Set - Knurled
 - 8415 Privacy Set - Knurled
- 56mmØ x 7mm rose



Sona

This design employs flowing, curvilinear forms of the lever and a clean smooth barrel tailored to your hand. The strong angles of the perpendicular neck and straight horizontal lines contrast the radiused edges.



Rose

- 8401 Lever Set
 - 8401D Dummy Lever
 - 8402 Passage Set
 - 8405 Privacy Set
- 56mmØ x 7mm rose

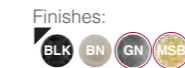

FEATURES AND BENEFITS

- > Solid brass forged and machined designs
- > Available from stock in four contemporary finishes Matt Black, Brushed Nickel, Graphite Nickel and Matt Satin Brass
- > Slim rose or longplate design
- > Can be used externally
- > Blank screws for external side of thru-fixing for a clean, minimal look
- > Solid brass screws
- > Full range of accessories available in all finishes (to match MSB, use USB)

- > **Lever Set**
Includes Levers only
- > **Dummy Set**
Includes single Lever Handle and 1152 Dummy Mount
- > **Passage Set**
Includes Levers and 1172 Tubular Latch
- > **Privacy Set**
Includes Levers, 1172 Tubular Latch, 1173 Privacy Bolt and NIDO Turn & Escape
- > **Recommended Longplate Latch Codes**
 - > 1172 Passage Latch
 - > 1173 Privacy Bolt and NIDO Turn & Escape

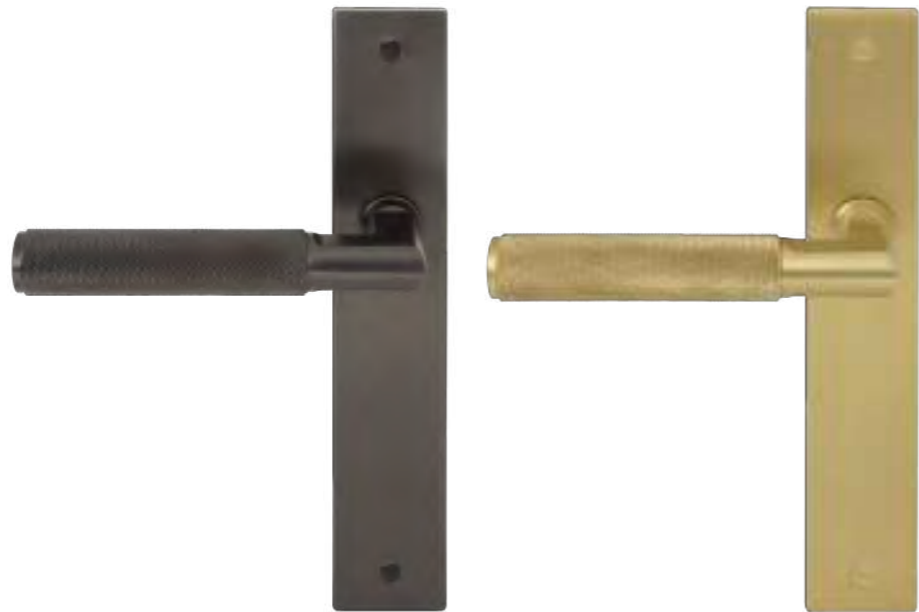

Longplate

- 8413 Lever on Longplate - Knurled
 - 8413-E85 Lever on Longplate - Knurled - Euro 85mm
 - 8413-P85 Lever on Longplate - Knurled - Priv 85mm
- 230mm x 40mm x 6mm plate

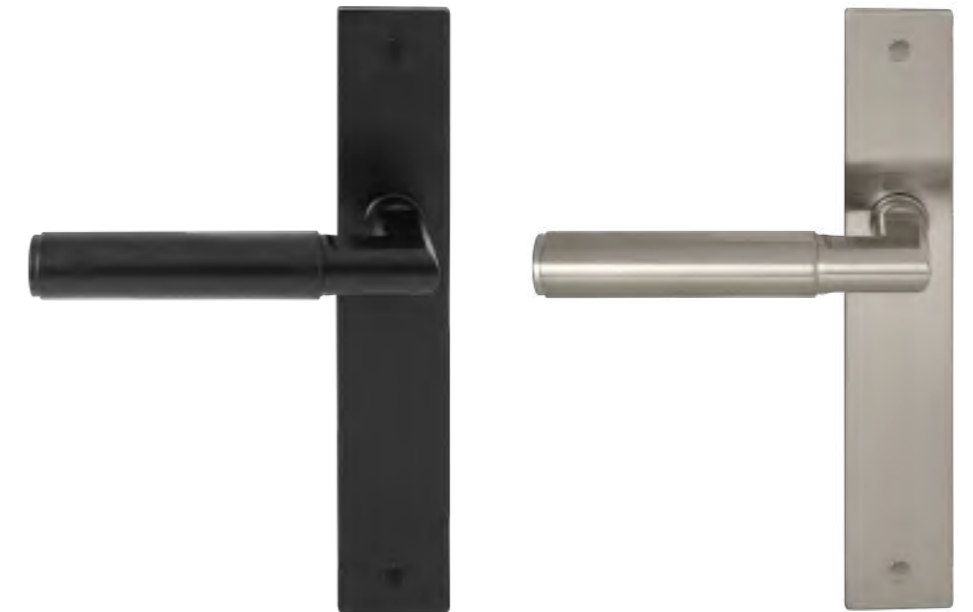
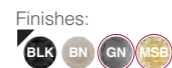

Longplate

- 8403 Lever on Longplate
 - 8403-E85 Lever on Longplate - Euro 85mm
 - 8403-P85 Lever on Longplate - Priv 85mm
- 230mm x 40mm x 6mm plate

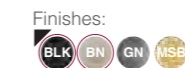

Verge

Inspired by industrial pipe systems with a dominant T-bar intersection of the neck to lever expanding into a barrel feature etched in diamond knurling.



Rose

- 8431 Lever Set - Knurled
 - 8431D Dummy Lever - Knurled
 - 8432 Passage Set - Knurled
 - 8435 Privacy Set - Knurled
- 56mmØ x 7mm rose

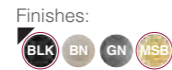

Linear

The fluid lines and organic curves morph into any home décor and design with the change of a finish. Knurling is stripped back to reveal the natural contours of the lever.



Rose

- 8421 Lever Set
 - 8421D Dummy Lever
 - 8422 Passage Set
 - 8425 Privacy Set
- 56mmØ x 7mm rose

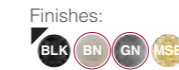

FEATURES AND BENEFITS

- > Solid brass forged and machined designs
- > Available from stock in four contemporary finishes Matt Black, Brushed Nickel, Graphite Nickel and Matt Satin Brass
- > Slim rose or longplate design
- > Can be used externally
- > Blank screws for external side of thru-fixing for a clean, minimal look
- > Solid brass screws
- > Full range of accessories available in all finishes (to match MSB, use USB)

- > **Lever Set**
Includes Levers only
- > **Dummy Set**
Includes single Lever Handle and 1152 Dummy Mount
- > **Passage Set**
Includes Levers and 1172 Tubular Latch
- > **Privacy Set**
Includes Levers, 1172 Tubular Latch, 1173 Privacy Bolt and NIDO Turn & Escape
- > **Recommended Longplate Latch Codes**
 - > 1172 Passage Latch
 - > 1173 Privacy Bolt and NIDO Turn & Escape

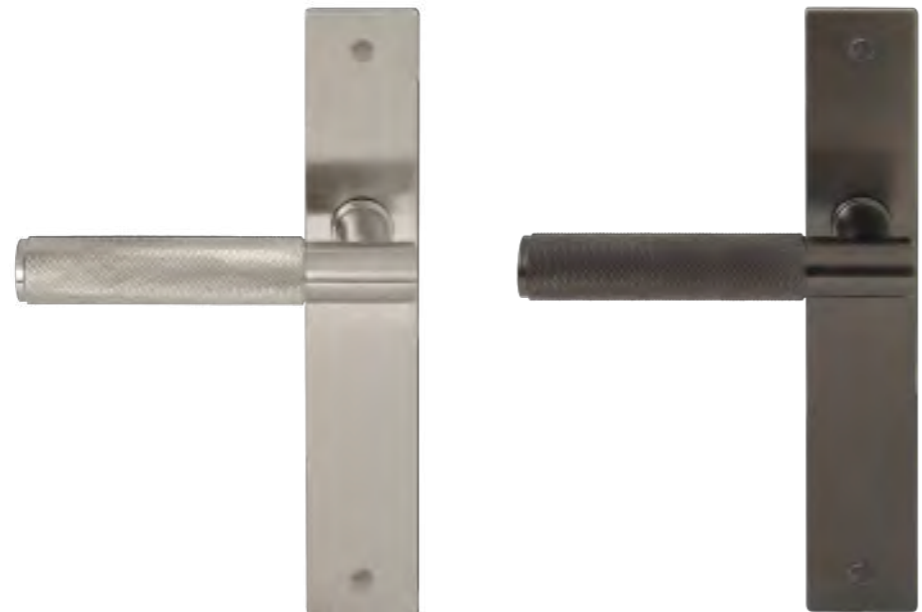

Longplate

- 8433 Lever on Longplate - Knurled
 - 8433-E85 Lever on Longplate - Knurled - Euro 85mm
 - 8433-P85 Lever on Longplate - Knurled - Priv 85mm
- 230mm x 40mm x 6mm plate

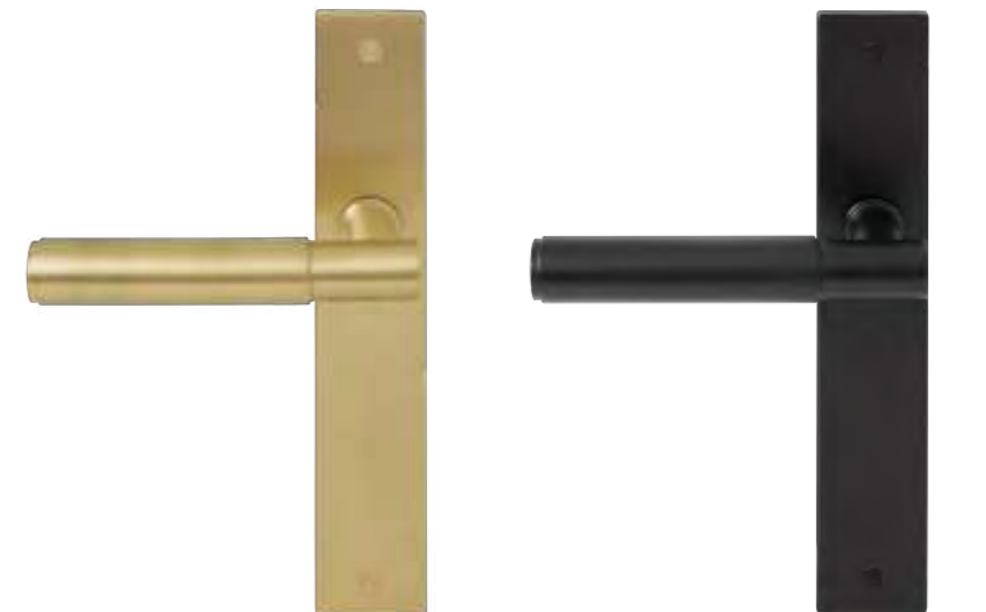

Longplate

- 8423 Lever on Longplate
 - 8423-E85 Lever on Longplate - Euro 85mm
 - 8423-P85 Lever on Longplate - Priv 85mm
- 230mm x 40mm x 6mm plate

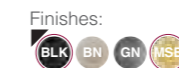

Modella

A subtly bold lever with soft curves, yet amplified profile. The sleek symmetry of the oval outline provides a timeless contour to suit any décor.



Rose

- 8441** Lever Set
 - 8441D** Dummy Lever
 - 8442** Passage Set
 - 8445** Privacy Set
- 56mm Ø x 7mm rose



Turn & Escape on Rose

- 8408** NIDO Turn & Escape
- 56mm Ø x 7mm roses
5mm spindle

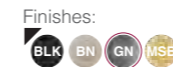

- 8409** NIDO Turn & Escape - Knurled
- 56mm Ø x 7mm roses
5mm spindle

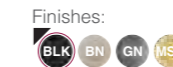

Escutcheons

- 8420** NIDO Euro pair
- 56mm Ø x 7mm

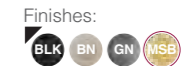

FEATURES AND BENEFITS

- > Solid brass forged and machined designs
- > Available from stock in four contemporary finishes Matt Black, Brushed Nickel, Graphite Nickel and Matt Satin Brass
- > Slim rose or longplate design
- > Can be used externally
- > Blank screws for external side of thru-fixing for a clean, minimal look
- > Solid brass screws
- > Full range of accessories available in all finishes (to match MSB, use USB)

- > **Lever Set**
Includes Levers only
- > **Dummy Set**
Includes single Lever Handle and 1152 Dummy Mount
- > **Passage Set**
Includes Levers and 1172 Tubular Latch
- > **Privacy Set**
Includes Levers, 1172 Tubular Latch, 1173 Privacy Bolt and NIDO Turn & Escape
- > **Recommended Longplate Latch Codes**
 - > 1172 Passage Latch
 - > 1173 Privacy Bolt and NIDO Turn & Escape

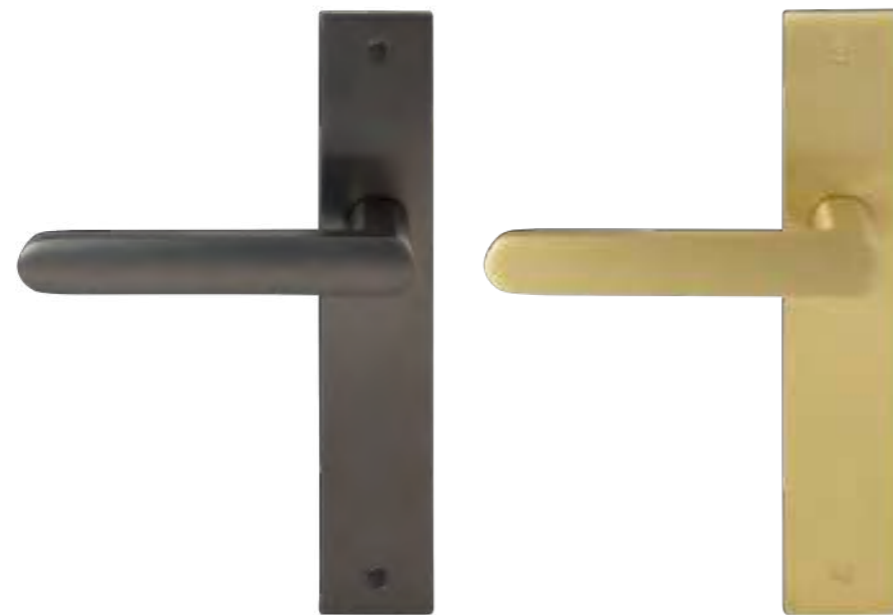

Longplate

- 8443** Lever on Longplate
 - 8443-E85** Lever on Longplate - Euro 85mm
 - 8443-P85** Lever on Longplate - Priv 85mm
- 230mm x 40mm x 6mm plate

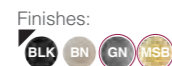

Privacy Sets

- 8400** NIDO Privacy Set
- 57mm b/s bolt
56mm Ø x 7mm roses
5mm spindle

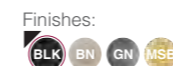

- 8410** NIDO Privacy Set - Knurled
- 57mm b/s bolt
56mm Ø x 7mm roses
5mm spindle

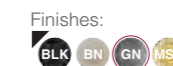



Traditional Lever Set - 3008-E48
Oil Rubbed Bronze



52mm Round Knob - Passage Set
Polished Brass



63mm Round Knob - Passage Set
Powdercoat Gloss Black

DOOR FURNITURE Traditional & Belmont



Oval Knob on Plate - Privacy Set
Powdercoat Matt Black

Traditional styles, timeless elegance.

All the features of Italian manufacture combined with traditional styling make this collection an obvious choice in restoration.



Oval Knob Set

5071 60mm Knob Set (AB available ex-stock)
5072 Passage Set
60mm Ø rose
Shown in RB

Finishes:
PB SC UB AB BHB DRB MAB MB NB OR PC RB SB USB



Round Knob Sets

5070 63mm Knob Set
5069 Passage Set
75mm Ø rose
Shown in SB



3010 52mm Knob Set
3011 Passage Set
60mm Ø rose
Shown in USB



Lever Set

3009 Lever Set
60mm Ø rose
Shown in NB



Lever Sets

3006L Standard Keyhole
3006 Blank Plate (pic)
3006-E48 Euro Keyhole
152mm x 43mm x 10mm plate
Shown in USB

Finishes:
PB SC UB AB BHB DRB MAB MB NB OR PC RB SB USB

4021 Standard Keyhole
5149 Blank Plate (pic)
5149-E48 Euro Keyhole
152mm x 52mm x 8mm plate
Shown in DRB
(Unavailable in SC)

3007 Standard Keyhole
3008 Blank Plate (pic)
3008-E48 Euro Keyhole
205mm x 49mm x 10mm plate
Shown in OR

Ascot Lever Set

8048 Standard Keyhole
8049 Blank Plate (pic)
8049-E48 Euro Keyhole
236mm x 37mm x 8mm plate
Shown in SC



Oval Knob Sets

5137 Standard Keyhole
5179 Blank Plate (pic)
5179-E48 Euro Keyhole
5127 Passage Set
60mm knob
152mm x 43mm x 10mm plate
Shown in PB

Finishes:
AB PB SC UB BHB DRB MAB MB NB OR PC RB SB USB

5128 Privacy Set
5129 Euro Locking Set
5130 Standard Key Locking Set

5002 Standard Keyhole
5003 Blank Plate (pic)
5003-E48 Euro Keyhole
5004 Passage Set
5005 Privacy Set
5006 Euro Locking Set
5007 Standard Key Locking Set
60mm knob
190mm x 63mm x 10mm plate
Shown in UB

Round Knob Sets

3002L Standard Keyhole
3002 Blank Plate (pic)
3002-E48 Euro Keyhole
3013 Passage Set
3014 Privacy Set
3015 Euro Locking Set
3016 Standard Key Locking Set
52mm knob
152mm x 43mm x 10mm plate
Shown in RB

3003 Standard Keyhole
3004 Blank Plate (pic)
3004-E48 Euro Keyhole
3017 Passage Set
3018 Privacy Set
3019 Euro Locking Set
3020 Standard Key Locking Set
52mm knob
205mm x 49mm x 10mm plate
Shown in AB

Economy and quality are cleverly combined in the Belmont Range.

Forged in solid brass, this Italian range is unmatched in quality and finish in its price bracket. This traditionally styled selection includes narrow backplates for narrow door stiles.

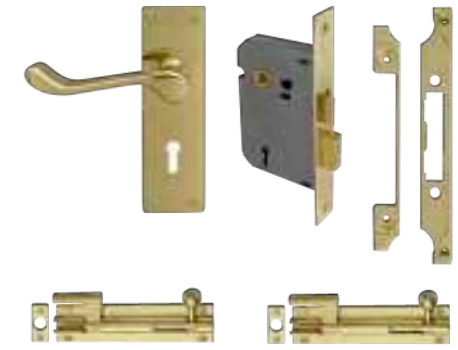

Lever Sets

7010 Standard Keyhole
7011 Blank Plate (pic)
7011-E48 Euro Keyhole
150mm x 36mm x 10mm plate
Shown in NB

Finishes:
PB SC UB AB BHB DRB MAB MB NB OR PC RB SB USB

7005 Standard Keyhole
7006 Blank Plate (pic)
7006-E48 Euro Keyhole
152mm x 43mm x 10mm plate
Shown in OR

7007 Standard Keyhole
7008 Blank Plate (pic)
7008-E48 Euro Keyhole
150mm x 36mm x 10mm plate
Shown in USB

French Door Kit

7062
Contains
> 1x 7005 Belmont Standard Keyhole Lever pair
> 1x 1107 3 Lever Mortice Lock
> Rebate Kit to suit 3 Lever Mortice Lock
> 2x 100mm Necked Barrel Bolts
> Fitting instructions

Features
> Three Lever medium security Lock (100 key differs)
> Easi-T Latch Reversal System (no need to open lock case to adjust)
> Adjustment tabs in striker to remove any door rattle
> Suits door thicknesses 38mm-42mm

Finishes:
PB SC AB PC



Lever Sets

7013 Lever Set
60mm Ø rose
Shown in RB

Finishes:
PB SC UB AB BHB DRB MAB MB NB OR PC RB SB USB

7012 Lever Set
60mm Ø rose
Shown in DRB



French Door Catches

5138 Set
Shown in USB
5157 & 5158 no longer available in SC

Finishes:
AB PB SC UB BHB DRB MAB MB NB OR PC RB SB USB

5157 Handle only
Shown in USB

5139 Set
Shown in AB

5158 Handle only
Shown in AB

- > **Passage Set**
Includes Knob Set and 1101 Tubular Latch.
- > **Privacy Set**
Includes Knob Set, 1110 Privacy Mortice, 8055 Turn and Release.
- > **Euro Locking**
Includes Knob Set Euro, 1115 Mortice Lock, 1148 Cylinder and Turn.
- > **Standard Key Locking**
Includes Knob Set with Standard Keyhole and 1104 5-Lever Mortice Lock.
- > **Recommended Latch Codes**
1172 Tubular Latch



Avante - Dummy Levers
Satin Chrome



Sigma - Passage Set
Satin Chrome



Quattro - Passage Set
Brushed Nickel



DOOR FURNITURE

Architectural



Prisma Longplate - Privacy 85mm
Satin Chrome

Contemporary door furniture featuring clean lines for that classy new home, apartment or office.

The Architectural range offers six superb styles that are ergonomically designed to suit the contours of your hand.



Quattro

- 8100 Lever Set
- 8099 Passage Set
- 8114 Dummy Lever - Single (non-handed)
- 55mm square rose
- Finishes:



Matrix

- 8129 Lever Set
- 8128 Passage Set
- 8130 Dummy Lever - Single (non-handed)
- 55mm square rose
- Finishes:



Quantum

- 8110 Lever Set
- 8109 Passage Set
- 8115 Dummy Lever - Single (non-handed)
- 55mm square rose
- Finishes:



Sigma

- 8143 Lever Set
- 8142 Passage Set
- 8144 Dummy Lever - Single (non-handed)
- 55mm square rose
- Finishes:



Prisma

- 8133 Lever Set
- 8132 Passage Set
- 8134 Dummy Lever - Single (LH or RH)
- 55mm square rose
- Finishes:



Avante

- 8137 Lever Set
- 8091 Passage Set
- 8138 Dummy Lever - Single (non-handed)
- 55mm Ø rose
- Finishes:

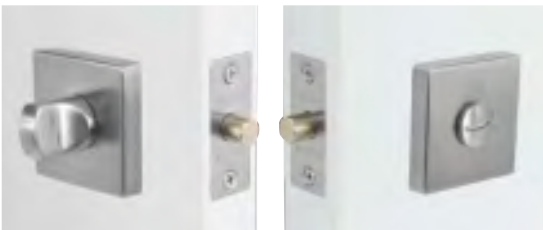

Privacy - Square

- 8101
- 60mm b/s Bolt
- 55mm square roses
- 5mm spindle
- Finishes:



Escutcheons

- 8102E Euro 55mm square rose
- 8102O Oval 55mm square rose
- 8136 Blank 55mm square rose
- > Blank Escutcheon for thru-fixing Dummy Handles
- Finishes:



Quattro Longplate

- 8126 Blank Plate (pic)
- 8126L Standard Keyhole
- 240mm x 45mm x 10mm plate
- Finishes:



Matrix Longplate

- 8131 Blank Plate (pic)
- 8131L Standard Keyhole
- 240mm x 45mm x 10mm plate
- Finishes:



Avante Longplate

- 8090 Blank Plate (pic)
- 8090L Standard Keyhole
- 233mm x 40mm x 10mm plate
- Narrow Plate Option**
- 8103 Blank Plate
- 8103L Standard Keyhole
- 233mm x 32mm x 10mm plate
- > Minimum lock backset 3'5mm
- Finishes:



Sigma Longplate

- 8145 Blank Plate (pic)
- 8145L Standard Keyhole
- 240mm x 45mm x 10mm plate
- Finishes:



Prisma Longplate

- 8135 Blank Plate (pic)
- 8135L Standard Keyhole
- 240mm x 45mm x 10mm plate
- Finishes:

HANDING FOR SINGLE/DUMMY HANDLES

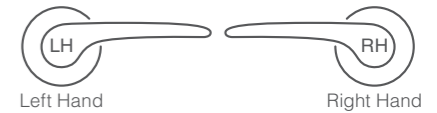

- > **Lever Set**
Includes Levers only
- > **Passage Set**
Includes Levers and 1131 Tubular Latch - 60mm backset
- > **Dummy Lever**
Includes single Lever Handle and 1152 Dummy Mount



Apollo - Entrance Set
Brushed Nickel



Vulcan - Passage Set
Brushed Nickel

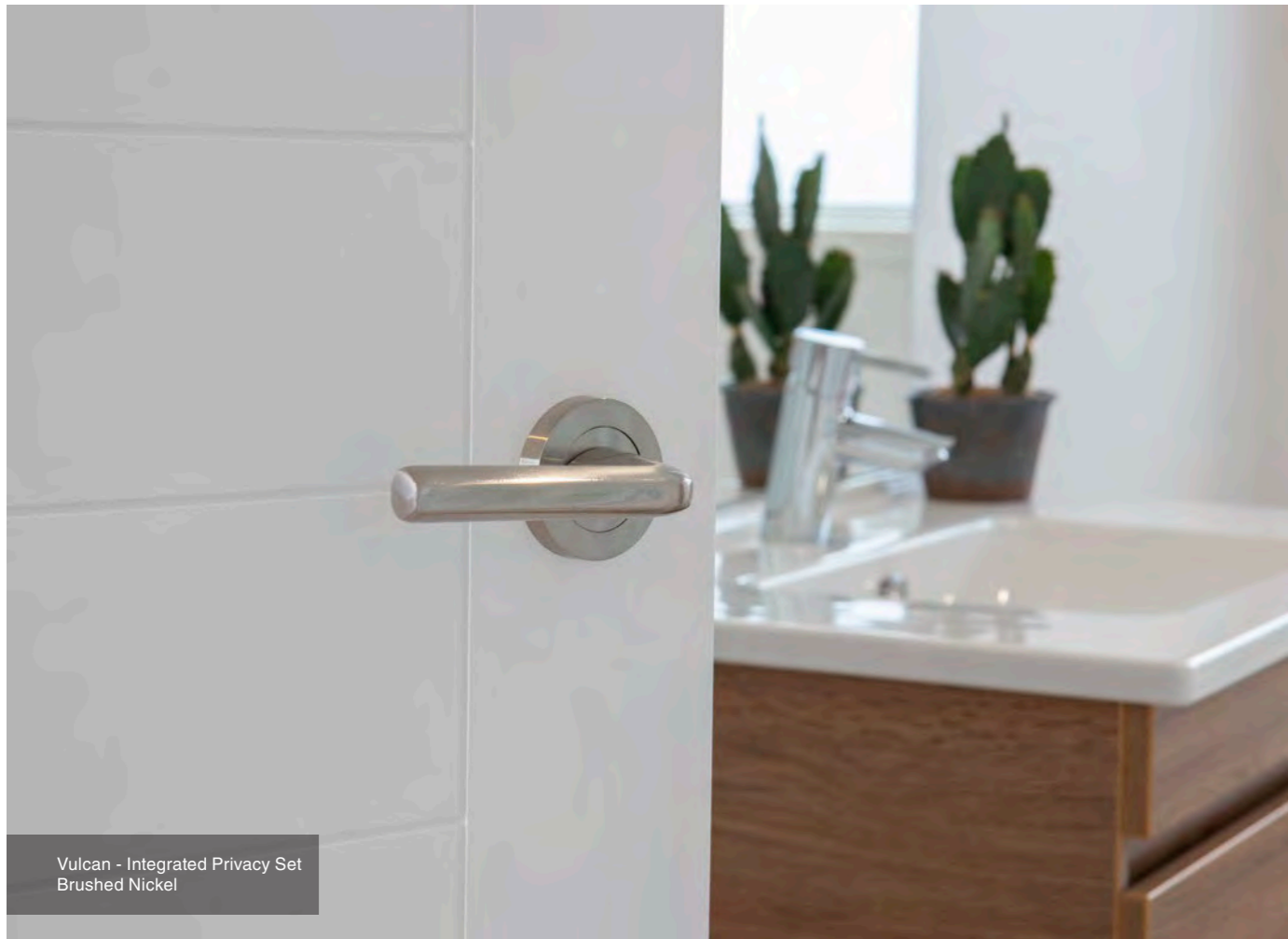

Vulcan - Integrated Privacy Set
Brushed Nickel



DOOR FURNITURE

Astron



Qube - Integrated Privacy Set
Brushed Nickel

Our Astron Series door furniture is perfect for the modern home.

The Astron range features architecturally inspired finishing touches that will last a lifetime. Six superb styles that are ergonomically designed to suit the contours of your hand.



Vulcan

- 7149 Lever Set
- 7149D Dummy Lever Single (non-handed)
- 7150 Passage Set
- 7151 Privacy Set
- 7153 Entrance Set
- 7198 Privacy Set – Integrated

55mm Ø rose



Titan

- 7113 Lever Set
- 7113D Dummy Lever Single (LH or RH)
- 7114 Passage Set
- 7115 Privacy Set
- 7117 Entrance Set
- 7197 Privacy Set – Integrated

55mm Ø rose



Vector

- 7106 Lever Set
- 7106D Dummy Lever Single (non-handed)
- 7107 Passage Set
- 7108 Privacy Set
- 7110 Entrance Set
- 7196 Privacy Set – Integrated

55mm Ø rose



Vulcan Longplate

- 7148 Blank Plate (pic)
- 7148L Standard Keyhole
- 7148-E48 Euro Keyhole
- 7148-E85 Euro Keyhole
- 7355 Passage Set
- 7365 Privacy Set
- 7152 Entrance Set

233mm x 40mm x 10mm plate



Titan Longplate

- 7112 Blank Plate (pic)
- 7112L Standard Keyhole
- 7112-E48 Euro Keyhole
- 7112-E85 Euro Keyhole
- 7356 Passage Set
- 7366 Privacy Set
- 7116 Entrance Set

233mm x 32mm x 10mm plate

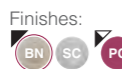

Vector Longplate

- 7105 Blank Plate (pic)
- 7105L Standard Keyhole
- 7105-E48 Euro Keyhole
- 7105-E85 Euro Keyhole
- 7354 Passage Set
- 7364 Privacy Set
- 7109 Entrance Set

233mm x 32mm x 10mm plate



Plate Options

- > Suitable for aluminium joinery
- > Compatible with 30mm lock backset
- > Hardware can be modified to suit other locking systems including Oval Profile Cylinder
- > Can be powdercoated to match your joinery



Qube

- 7058 Lever Set
- 7058D Dummy Lever Single (non-handed)
- 7059 Passage Set
- 7060 Privacy Set
- 7085 Entrance Set
- 7195 Privacy Set – Integrated

55mm Ø rose

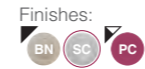

Juno

- 7019 Lever Set
- 7019D Dummy Lever Single (LH or RH)
- 7036 Passage Set
- 7037 Privacy Set
- 7081 Entrance Set
- 7192 Privacy Set – Integrated

55mm Ø rose

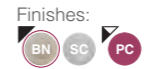

Apollo

- 7015 Lever Set
- 7015D Dummy Lever Single (LH or RH)
- 7033 Passage Set
- 7034 Privacy Set
- 7080 Entrance Set
- 7191 Privacy Set – Integrated

55mm Ø rose



Qube Longplate

- 7057 Blank Plate (pic)
- 7057L Standard Keyhole
- 7057-E48 Euro Keyhole
- 7057-E85 Euro Keyhole
- 7353 Passage Set
- 7363 Privacy Set
- 7061 Entrance Set

233mm x 32mm x 10mm plate



Juno Longplate

- 7046 Blank Plate
- 7046L Standard Keyhole
- 7046-E48 Euro Keyhole
- 7046-E85 Euro Keyhole (pic)
- 7352 Passage Set
- 7362 Privacy Set
- 7038 Entrance Set

233mm x 32mm x 10mm plate



Apollo Longplate

- 7045 Blank Plate (pic)
- 7045L Standard Keyhole
- 7045-E48 Euro Keyhole
- 7045-E85 Euro Keyhole
- 7351 Passage Set
- 7361 Privacy Set
- 7035 Entrance Set

233mm x 32mm x 10mm plate



- > **Lever Set**
Includes Levers only
 - > **Passage Set**
Includes Levers and 1131 Tubular Latch - 60mm backset
 - > **Dummy Lever**
Includes single Lever Handle and 1152 Dummy Mount
 - > **Privacy Set**
Includes Levers, 1131 Tubular Latch and 7032 Privacy Bolt, Turn and Escape
 - > **Integrated Privacy Set**
Includes Levers and 60mm b/s Tubular Privacy Latch
 - > **Entrance Set**
Includes Levers, 1143 Euro Mortice Lock, 7020 Escutcheons and 1148 Euro Cylinder and Turn
 - > **Longplate Passage Set**
Includes Levers, 1131 Tubular Latch
 - > **Longplate Privacy Set**
Includes Levers, 1131 Tubular Latch and 1120 Privacy Bolt and 8055 Turn & Release
 - > **Longplate Entrance Set**
Includes Levers, Euro 85 Longplate, 1143 Euro Lockcase and 1148 Euro Cylinder and Turn
- Ref Inside Back Cover for exploded views

HANDING FOR SINGLE/DUMMY HANDLES





Ellipse Lever Set
Stainless Steel

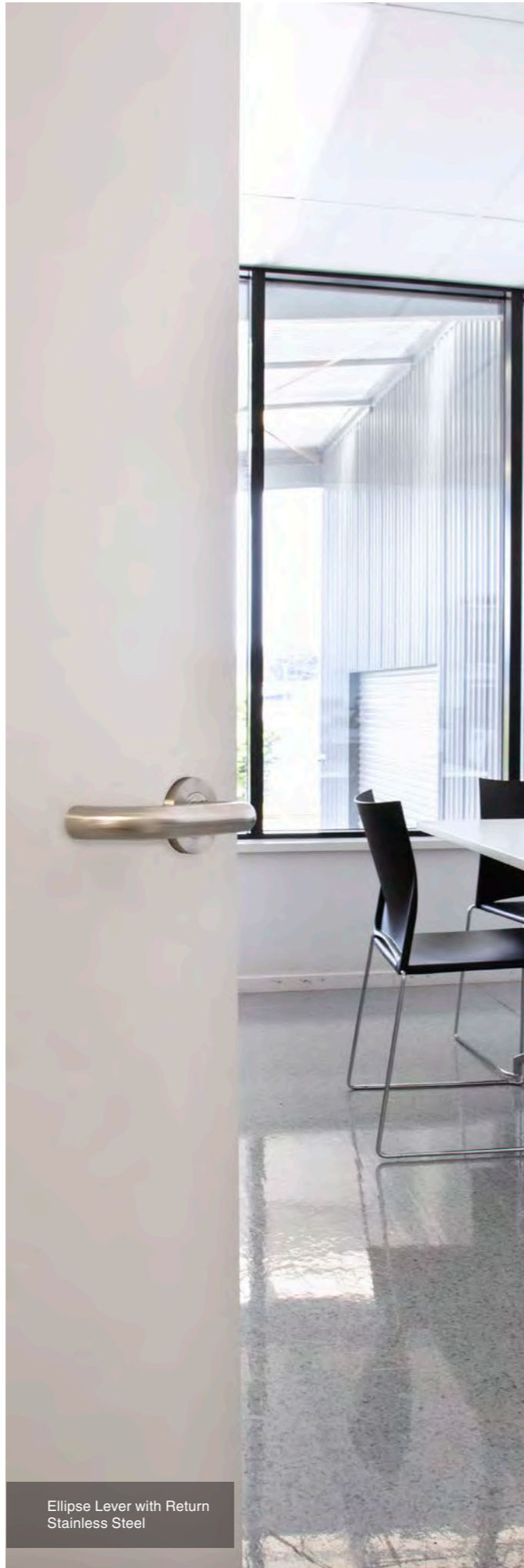

Ellipse Lever with Return
Stainless Steel

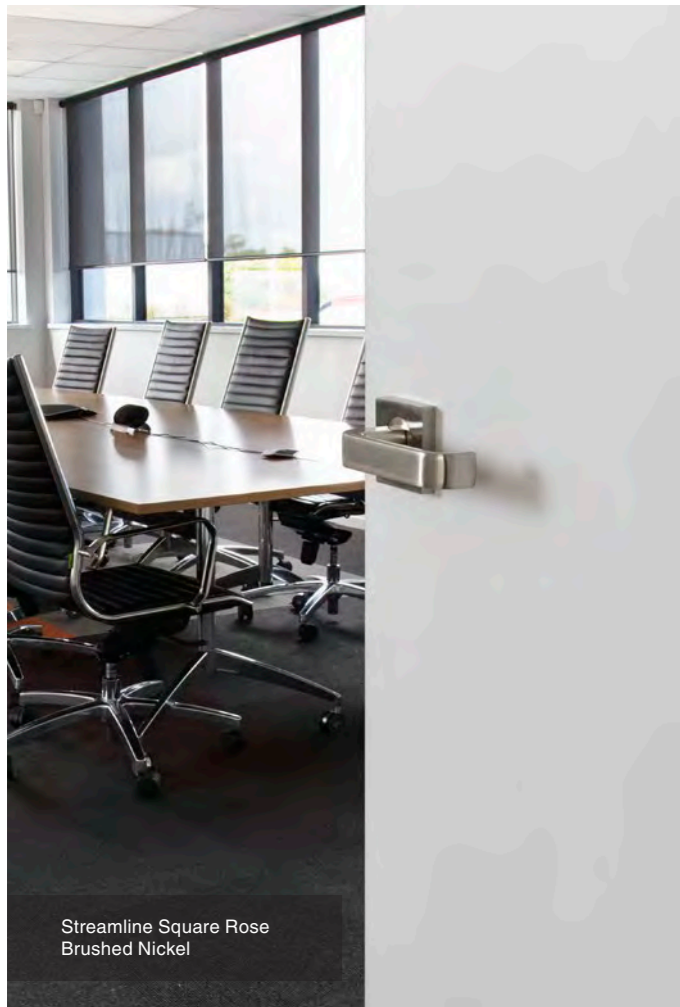

Streamline Square Rose
Brushed Nickel

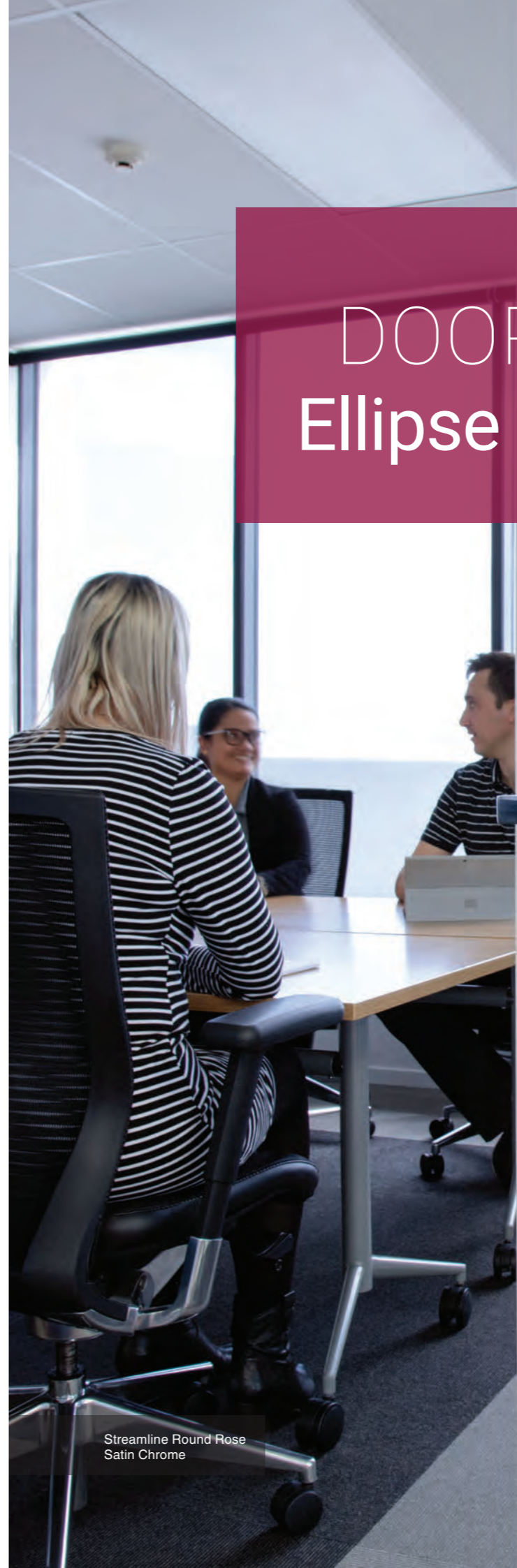

DOOR FURNITURE

Ellipse & Streamline



Streamline Round Rose
Satin Chrome

The Ellipse and Streamline ranges provide a contemporary solution for light-medium commercial environments.

Both ranges offer options with a substantial return to the door making them perfect for retirement villages and public use buildings that can be used both internally and externally.



Ellipse Lever Set

7344 Oval 64mm
178mm x 44mm x 8mm plate

Finishes:
SS PC

7343 Blank/Turn
178mm x 44mm x 8mm plate

Finishes:
SS PC

Ellipse Lever with Return Set

7350 Oval/Turn
178mm x 44mm x 8mm plate

Finishes:
SS PC

7347 Blank/Oval
178mm x 44mm x 8mm plate
Shown in Matt Black (PC)

Finishes:
SS PC

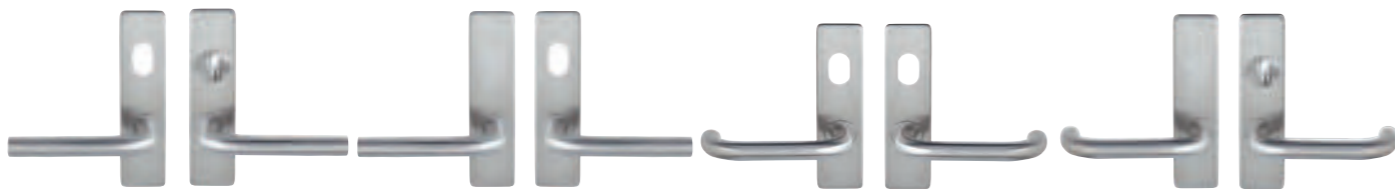

Ellipse Lever Set

7345 Oval/Turn
178mm x 44mm x 8mm plate

Finishes:
SS PC

7342 Blank/Oval
178mm x 44mm x 8mm plate

Finishes:
SS PC

Ellipse Lever with Return Set

7349 Oval 64mm
178mm x 44mm x 8mm plate

Finishes:
SS PC

7348 Blank/Turn
178mm x 44mm x 8mm plate

Finishes:
SS PC



Ellipse Lever Set

7338 Blank
7338-E48 Euro (pic)
7338-P57 Privacy
178mm x 44mm x 8mm plate

Finishes:
SS PC

7341 Blank
178mm x 44mm x 8mm plate

Finishes:
SS PC

Ellipse Lever with Return Set

7339 Blank (pic)
7339-E48 Euro
7339-P57 Privacy
178mm x 44mm x 8mm plate

Finishes:
SS PC

7346 Blank
178mm x 44mm x 8mm plate

Finishes:
SS PC

FEATURES AND BENEFITS

- > Designed to National DDA standards
- > Substantial return to the door at the end of the lever for ease of grip when operating the handle

- > Suitable for interior and exterior applications
- > Excellent for use within commercial mortice locks



Ellipse Lever

7330 Lever Set
7331 Passage Set
50mm Ø rose

Finishes:
SS PC



Ellipse Lever with Return

7332 Lever Set
7333 Passage Set
50mm Ø rose

Finishes:
SS PC



Streamline Round Rose

7313 Lever Set
7313D Dummy Lever - Single (LH or RH)
7314 Passage Set
54mm Ø rose

Finishes:
BN SC PC

7315 Privacy Set - inc. Auxiliary Bolt
7316 Entrance Set
7317 Privacy Set - Integrated



Streamline Square Rose

7318 Lever Set
7318D Dummy Lever - Single (LH or RH)
7319 Passage Set
54mm square rose

Finishes:
BN SC PC

7320 Privacy Set - inc. Auxiliary Bolt
7321 Entrance Set
7322 Privacy Set - Integrated



Turn & Release

7334 Turn & Release only
7335 Turn & Release with 1173 Heavy Duty Bolt, 57mm b/s

7337 Turn only with flat tail bar
50mm Ø rose

Finishes:
SS PC

Escutcheons

7336E Euro (Pair)
50mm Ø rose

Finishes:
SS PC

7336O Oval (Pair)
50mm Ø rose

- > **Lever Set**
Includes Levers only
- > **Dummy Lever**
Includes single Lever Handle and 1152 Dummy Mount
- > **Ellipse Passage Set**
Includes Levers and 1172 Heavy Duty Latch
- > **Streamline Passage Set**
Includes Levers and 1131 Tubular Latch - 60mm backset
- > **Streamline Privacy Set**
Includes Levers, 1131 Tubular Latch and 7032 Privacy Bolt
- > **Streamline Entrance Set**
Includes Levers, 1143 Mortice Lock, 1148 Cylinder and 7020 Escutcheons



Phoenix - Passage Set
Matt Black



Pegasus - Privacy Set
Brushed Nickel



Pegasus Elite - Dummy Lever
Graphite Nickel



DOOR FURNITURE Galaxy



Pegasus - Passage Set
Graphite Nickel

The Galaxy range represents a contemporary selection of modern lever designs, mixing clean lines with radiused edging for maximum user comfort.

These levers are available on both round and square backing plates giving you the choice to match in with the desired look of your home.

Galaxy is complete with Windsor's patented rapidFIT® installation system, increasing both install speed and overall strength and durability on the door.



NEW

Pegasus

7201 Lever Set 7201D Dummy Lever (non-handed) 7202 Passage Set	7203 Privacy Set 7204 Entrance Set	7205 Privacy Set – Integrated 54mm Ø rose	Finishes: BLK BN GN MC PC
---	---	---	------------------------------

Pegasus

7201 Lever Set 7201D Dummy Lever (non-handed) 7202 Passage Set	7203 Privacy Set 7204 Entrance Set	7205 Privacy Set – Integrated 54mm Ø rose	Finishes: BLK BN GN MC PC
---	---	---	------------------------------

NEW

Pegasus Elite

7211 Lever Set 7211D Dummy Lever (non-handed) 7212 Passage Set	7213 Privacy Set (inc. Auxiliary Bolt) 7214 Entrance Set	7215 Privacy Set – Integrated 54mm square rose	Finishes: BLK BN GN MC PC
---	---	--	------------------------------

Pegasus Elite

7211 Lever Set 7211D Dummy Lever (non-handed) 7212 Passage Set	7213 Privacy Set (inc. Auxiliary Bolt) 7214 Entrance Set	7215 Privacy Set – Integrated 54mm square rose	Finishes: BLK BN GN MC PC
---	---	--	------------------------------

NEW

Phoenix

7221 Lever Set 7221D Dummy Lever (non-handed) 7222 Passage Set	7223 Privacy Set (inc. Auxiliary Bolt) 7224 Entrance Set	7225 Privacy Set – Integrated 54mm Ø rose	Finishes: BLK BN GN MC PC
---	---	---	------------------------------

Phoenix

7221 Lever Set 7221D Dummy Lever (non-handed) 7222 Passage Set	7223 Privacy Set (inc. Auxiliary Bolt) 7224 Entrance Set	7225 Privacy Set – Integrated 54mm Ø rose	Finishes: BLK BN GN MC PC
---	---	---	------------------------------

NEW

Phoenix Elite

7231 Lever Set 7231D Dummy Lever (non-handed) 7232 Passage Set	7233 Privacy Set (inc. Auxiliary Bolt) 7234 Entrance Set	7235 Privacy Set – Integrated 54mm Ø rose	Finishes: BLK BN GN MC PC
---	---	---	------------------------------

Phoenix Elite

7231 Lever Set 7231D Dummy Lever (non-handed) 7232 Passage Set	7233 Privacy Set (inc. Auxiliary Bolt) 7234 Entrance Set	7235 Privacy Set – Integrated 54mm Ø rose	Finishes: BLK BN GN MC PC
---	---	---	------------------------------

FEATURES AND BENEFITS

- > Designed for comfort
- > Small 54mm rose with concealed fixings
- > Screw-on rose
- > Complete house packages available in Graphite Nickel, Brushed Nickel, Matt Chrome and Matt Black finishes
- > Solid zinc alloy construction
- > Suits both left and right handed doors
- > Matching accessories available
- > Patented rapidFIT® installation system
- > Suits 48mm drillout
- > 60mm backset

- > **Lever Set**
Includes Levers only
- > **Dummy Set**
Includes single Lever Handle and 1152 Dummy Mount
- > **Passage Set**
Includes Levers and 1357 Tubular Latch - 60mm backset
- > **Privacy Set**
Includes Levers, 1357 Tubular Latch (60mm backset) and 9034 Privacy Bolt, Turn and Escape
- > **Entrance Set**
Includes Levers, 1143 Euro Mortice Lock, 9035/9045 Escutcheons and 1148 Euro Cylinder and Turn
- > **Integrated Privacy Set**
Includes Levers and 1358 Tubular Privacy Latch - 60mm backset
Ref Inside Back Cover for exploded views



Apex Elite - Passage Set
Matt Black



Helix - Passage Set
Brushed Nickel

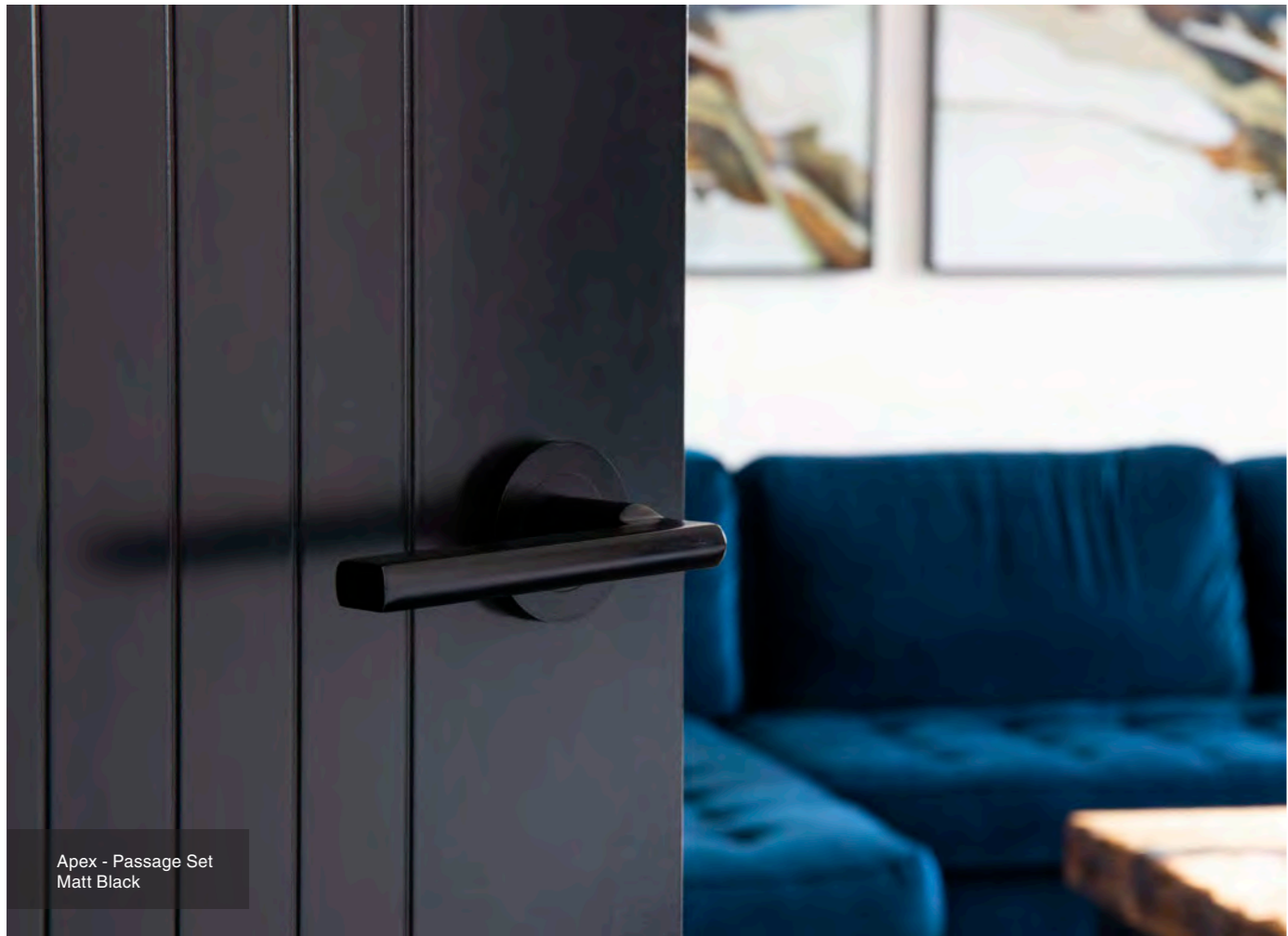

Apex - Passage Set
Matt Black



Apex - Integrated Privacy Set
Matt Black

DOOR FURNITURE

Futura



The Futura range combines the latest European designs with modern finishes and is constructed from solid aluminium.

These smooth ergonomic handles with radiused edges give you the feel to match the design.

Futura is complete with Windsor's patented rapidFIT® installation system, increasing both install speed and overall strength and durability on the door.



Apex

- 9018 Lever Set
- 9018D Dummy Lever -Single (non-handed)
- 9019 Passage Set

- 9020 Privacy Set (inc. Auxiliary Bolt)
- 9021 Locking Set

- 9051 Privacy Set - Integrated
- 54mm Ø rose

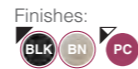

Apex Elite

- 9036 Lever Set
- 9036D Dummy Lever -Single (non-handed)
- 9037 Passage Set

- 9038 Privacy Set (inc. Auxiliary Bolt)
- 9039 Locking Set

- 9055 Privacy Set - Integrated
- 54mm square rose



Corbel

- 9022 Lever Set
- 9022D Dummy Lever - Single (non-handed)
- 9023 Passage Set

- 9024 Privacy Set (inc. Auxiliary Bolt)
- 9025 Locking Set

- 9052 Privacy Set - Integrated
- 54mm Ø rose

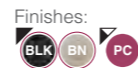

Corbel Elite

- 9040 Lever Set
- 9040D Dummy Lever - Single (non-handed)
- 9041 Passage Set

- 9042 Privacy Set (inc. Auxiliary Bolt)
- 9043 Locking Set

- 9056 Privacy Set - Integrated
- 54mm square rose



Helix

- 9030 Lever Set
- 9030D Dummy Lever - Single (LH or RH)
- 9031 Passage Set

- 9032 Privacy Set (inc. Auxiliary Bolt)
- 9033 Locking Set

- 9054 Privacy Set - Integrated
- 54mm Ø rose

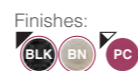

Talon

- 9026 Lever Set
- 9026D Dummy Lever - Single (LH or RH)
- 9027 Passage Set

- 9028 Privacy Set (inc. Auxiliary Bolt)
- 9029 Locking Set

- 9053 Privacy Set - Integrated
- 54mm Ø rose



FEATURES AND BENEFITS

- > Designed for comfort
- > Small 54mm rose with concealed fixings
- > Screw-on rose
- > Complete house packages available in Brushed Nickel and Matt Black finishes
- > Patented rapidFIT® installation system
- > Suits 48mm drillout
- > 60mm backset
- > Not for external use

HANDING FOR SINGLE/DUMMY HANDLES



- > **Lever Set**
Includes Levers only
 - > **Dummy Set**
Includes single Lever Handle and 1152 Dummy Mount
 - > **Passage Set**
Includes Levers and 1357 Tubular Latch - 60mm backset
 - > **Privacy Set**
Includes Levers, 1357 Tubular Latch (60mm backset) and 9034 Privacy Bolt, Turn and Escape
 - > **Locking Set**
Includes Levers, 1143 Euro Mortice Lock, Escutcheons and 1148 Euro Cylinder and Turn
 - > **Integrated Privacy Set**
Includes Levers and 1358 Tubular Privacy Latch - 60mm backset
- Ref Inside Back Cover for exploded views

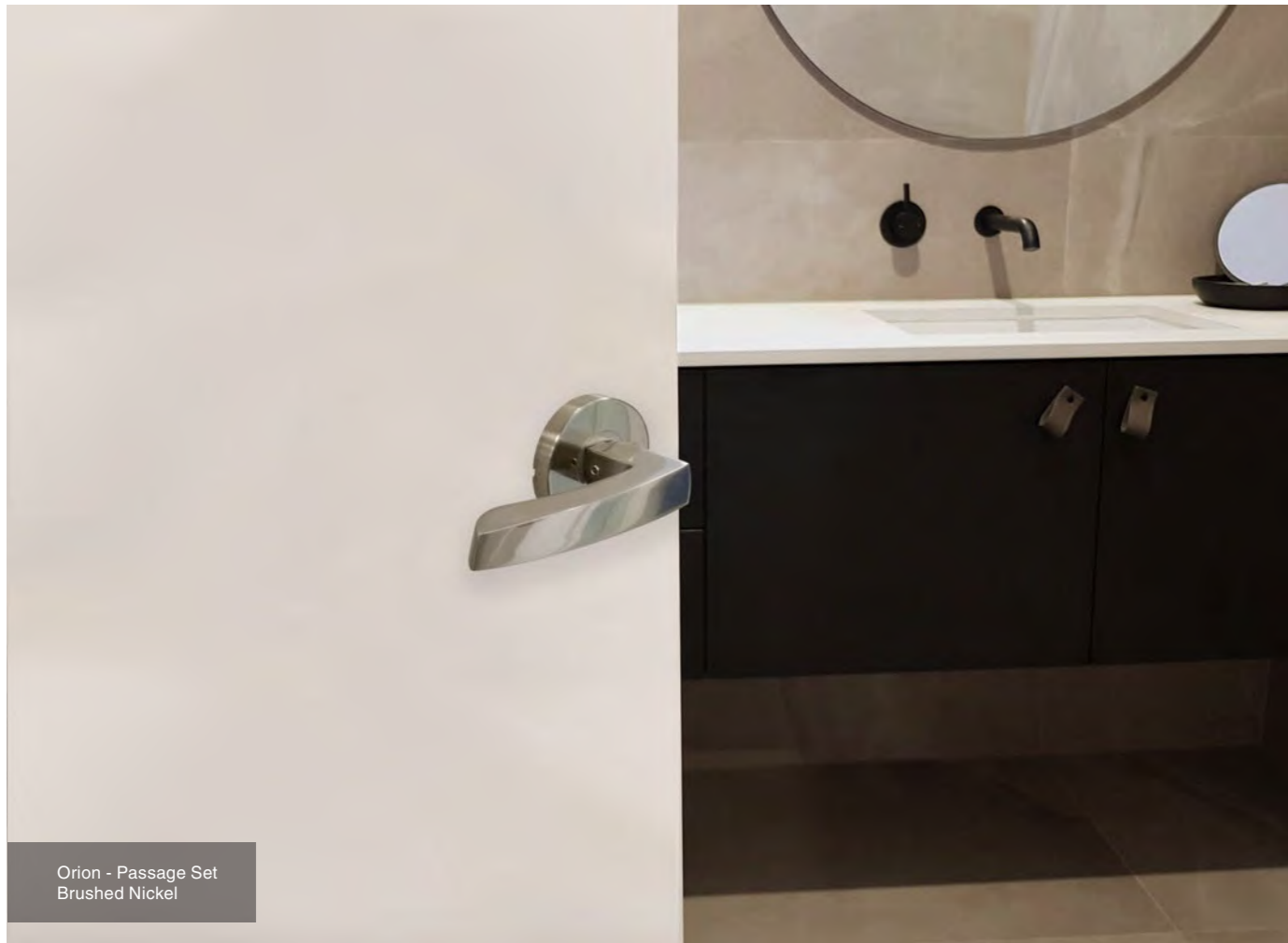

Orion - Passage Set
Brushed Nickel



Polaris - Passage Set
Brushed Nickel



NEW

DOOR FURNITURE

Halo



Hydra - Passage Set
Matt Black

The Halo range has been designed as the ideal solution to retrofitting projects with the 67mm rose perfectly covering any 54mm holes in the door, achieving a smart and contemporary look on original doors.

It is constructed from solid aluminium and fitted with a strong spring mechanism, which gives you a positive feel on the door and built to last the distance.

FEATURES AND BENEFITS

- > Large press-on rose
- > Ideal for both new builds and retrofitting applications
- > Concealed fixings
- > Complete house packages available in Brushed Nickel, Graphite Nickel and Matt Black finishes
- > Single direction lever action
- > Suits 54mm drillout
- > 60mm backset
- > Latch guide prongs on levers for simple, fast installation and added strength on the door
- > Not for external use

- > **Dummy Lever**
Includes single Lever Handle and 1152 Dummy Mount
- > **Passage Set**
Includes Levers and 1357 Tubular Latch - 60mm backset
- > **Integrated Privacy Set**
Includes Levers and 1358 Tubular Privacy Latch - 60mm backset



Hydra

9201D Dummy Lever – Single (non-handed)
9202 Passage Set
9205 Privacy Set – Integrated
 67mm Ø rose

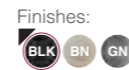

Hydra

9201D Dummy Lever – Single (non-handed)
9202 Passage Set
9205 Privacy Set – Integrated
 67mm Ø rose



Orion

9211D Dummy Lever – Single (non-handed)
9212 Passage Set
9215 Privacy Set – Integrated
 67mm Ø rose

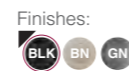

Orion

9211D Dummy Lever – Single (non-handed)
9212 Passage Set
9215 Privacy Set – Integrated
 67mm Ø rose



Polaris

9221D Dummy Lever – Single (non-handed)
9222 Passage Set
9225 Privacy Set – Integrated
 67mm Ø rose

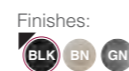

Polaris

9221D Dummy Lever – Single (non-handed)
9222 Passage Set
9225 Privacy Set – Integrated
 67mm Ø rose

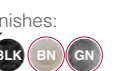

DOOR FURNITURE

Jura & Contract



Alto - Integrated Privacy Set
Brushed Nickel

The Jura and Contract ranges offer a fantastic retro-fit option. Unique styling and economy pricing will also appeal to the entry level new house market.

Jura



Alto

- 9005 Passage Set (pic)
- 9006 Privacy Set – Integrated
- 65mm Ø rose
- > Adjustable 60mm – 70mm backset latch
- > Suits 54mm drill-out pattern

Finishes:



Kona

- 9008 Passage Set
- 9009 Privacy Set – Integrated (pic)
- 65mm Ø rose
- > Adjustable 60mm – 70mm backset latch
- > Suits 54mm drill-out pattern

Finishes:



Contract



Lever Set

- 9013 Standard Keyhole (pic)
- 9014 Blank Plate
- 155mm x 42mm plate
- > Interior use only

Finishes:



Locking Set

- 9016 Locking Set (9013 and 1108 Lock, 57mm b/s, 78mm c/s)
- > Interior use only

Finishes:



Lever & Passage Set

- 9015 Lever Set (pic)
- 9017 Passage Set (9015 and 1100 latch)
- 120mm x 42mm plate
- > Interior use only

Finishes:



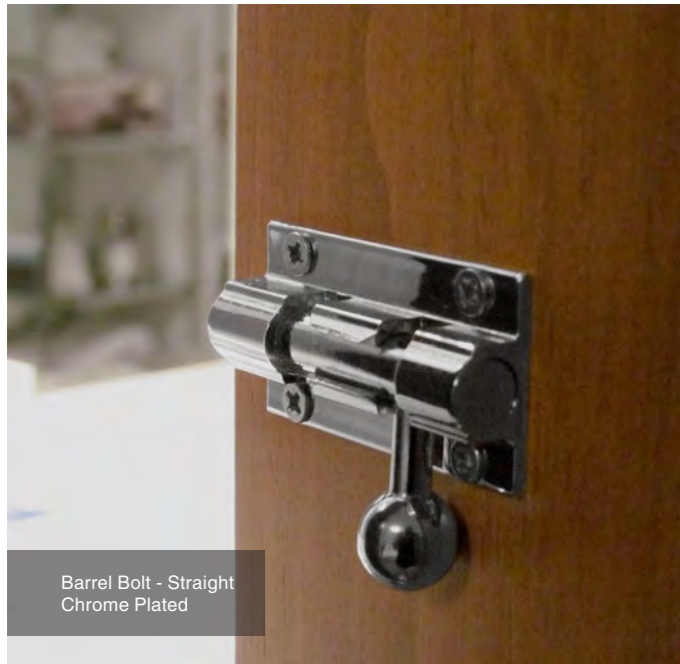

Barrel Bolt - Straight
Chrome Plated



Auto Door Holder
Oil Rubbed Bronze



Hinge - Loosepin
Graphite Nickel



Cup Magnet

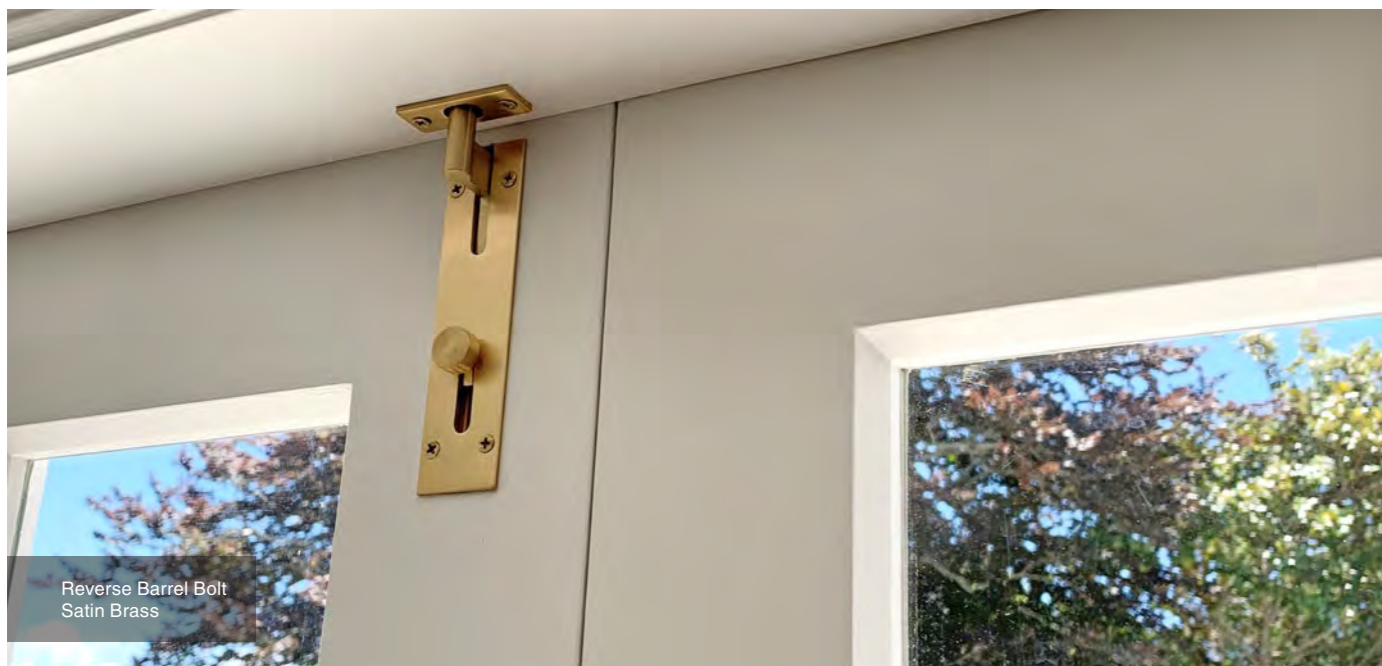

Reverse Barrel Bolt
Satin Brass

DOOR ACCESSORIES

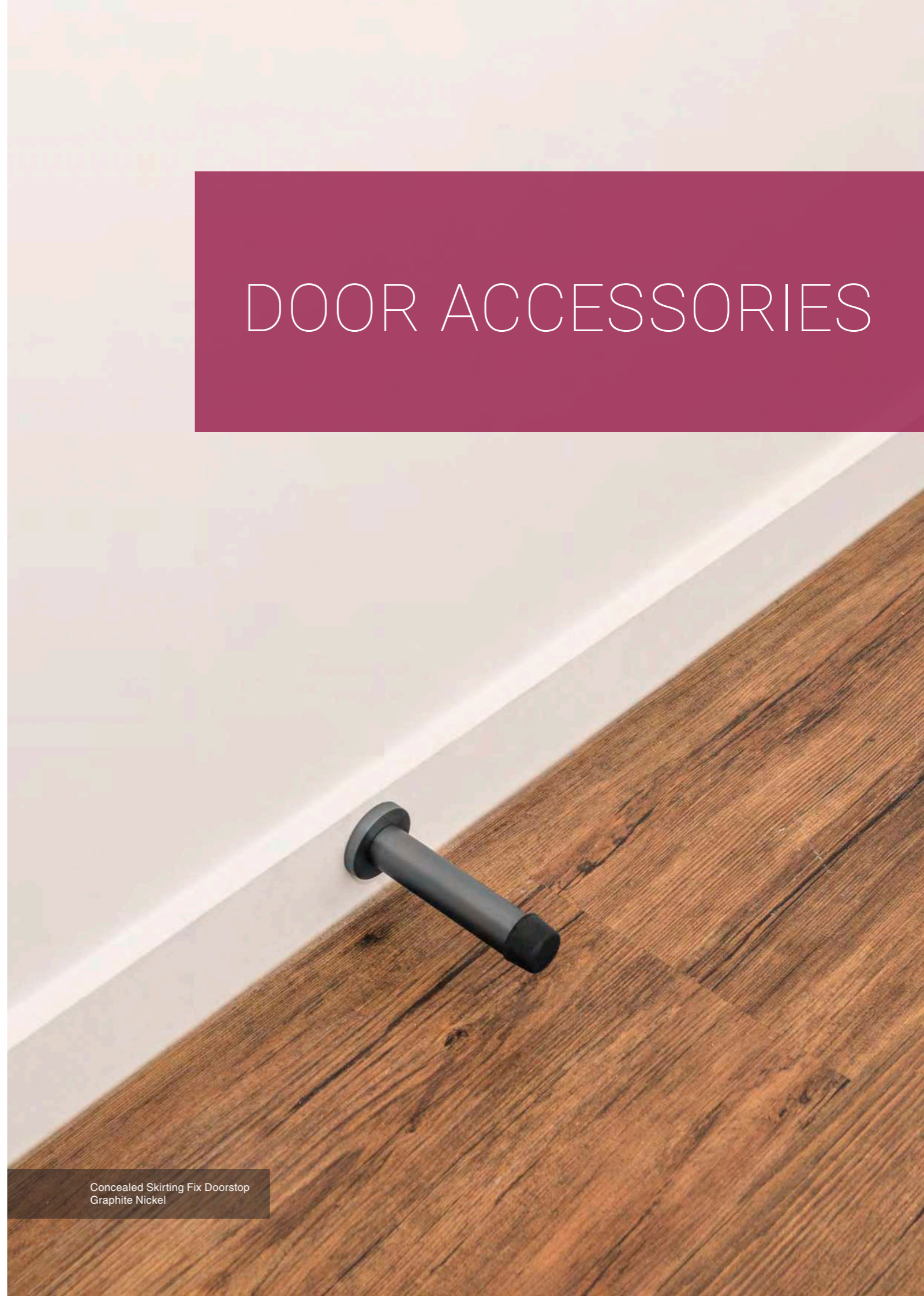

Concealed Skirting Fix Doorstop
Graphite Nickel

DOORSTOPS



Floor Mount

- 5062** 22mm x 30mm
Finishes: AB, BN, CP, PB, SC, UB, BHB, DRB, MAB, MB, NB, OR, PC, RB, SB, USB
- 5249** 38mm x 38mm 2 Piece
> Suitable for wooden and concrete floors
Finishes: BN, SA
- 5256** 38mm x 38mm
> Now available in all special finishes
Finishes: BLK, BN, GN, SA, UB, AB, BHB, DRB, MAB, MB, NB, OR, PB, PC, RB, SB, UB, USB
- 5264** 60mm x 38mm
Finishes: BLK, BN, GN, SA, PC
- 5307** 90mm x 38mm
> Complete with screw and dynabolt fix options
Finishes: BN, SA, PC
- 5274** 38mm x 38mm
> Complete with screw and dynabolt fix options
> Suitable for wooden and concrete floors
Finishes: BN, SA, PC
- 5278** 60mm x 38mm
Finishes: BN, SA, PC



Concealed Skirting Fix

- 5090** 73mm x 40mm
Finishes: AB, BN, CP, PB, SC, UB, BHB, DRB, MAB, MB, NB, OR, PC, RB, SB, USB
- 5229** 75mm x 30mm
5299 3 pack 75mm x 30mm (3 packs available in BLK, BN & SC only)
Finishes: PC, AB, BLK, BN, CP, PB, SC, GN, PC
- 5341** 30mm x 30mm
> Ideal for situations where a door opens flush against a cupboard or unit with minimal room for a stopper
Finishes: BN, SA, GN, PC
- 5342** 50mm x 30mm
Finishes: BLK, BN, SA, GN, PC
- 5262** 80mm x 19mm
Finishes: BLK, BN, GN, SA, PC
- 5240** 85mm x 30mm
5298 3 pack 85mm x 30mm (3 packs available only in BN, BLK & SA)
Finishes: AB, BLK, BN, GN, PB, SA, UB, BHB, DRB, MAB, MB, NB, OR, PC, RB, SB, USB
- 5265** 110mm x 30mm
Finishes: BN, SC, PC

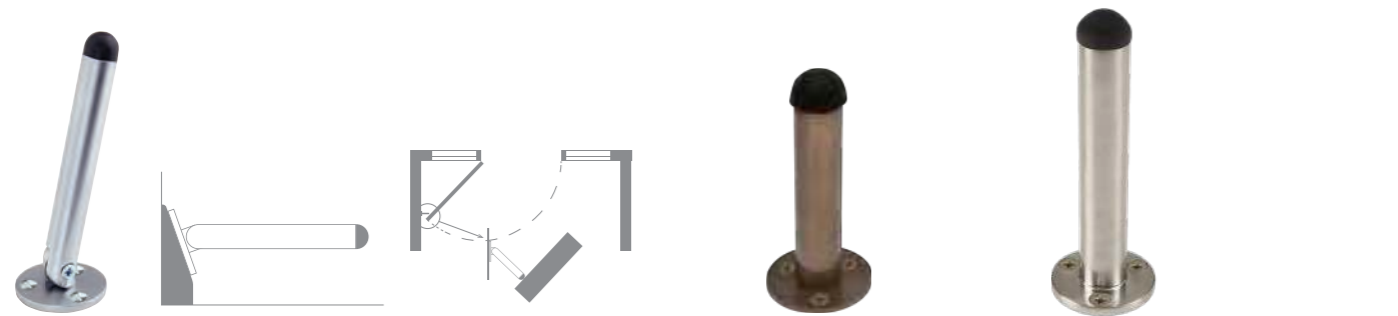

Adjustable Angle Doorstop

- 5315** 110mm x 40mm
> Perfect for doors next to side-lights or splayed skirtings
> Adjust angle of doorstop to ensure it meets the door at 90°
Finishes: BN, SC, PC

Skirting Fix

- 5186** 87mm x 40mm
Finishes: BN, PB, SC, UB, AB, BHB, DRB, MAB, MB, NB, OR, PC, RB, SB, USB
- 5230** 110mm x 38mm
> 110mm doorstops are ideal in a situation where the door opens against a towel rail
Finishes: BN, SC, PC

DOOR HOLDERS & DOORSTOPS



Door Holder

- 5133** Engaged length 88mm
Powdercoat colours stocked: Matt Black
Finishes: AB, BN, PB, SC, UB, BHB, DRB, MAB, MB, NB, OR, PC, RB, SB, USB
- 5258** Engaged length 93mm
43mm Ø base
Powdercoat colours stocked: Appliance White, Arctic White, Black, Bronco, Desert Sand, Grey Friars, Ironsand, Karaka, Off White, Sandstone Grey, Silver Pearl, Titania
Finishes: BN, SC, BLK, PC
- 5357** Magnetic Doorstop
50mm x 75mm
> Wall or floor mount
> Not recommended for outdoor use
Finishes: BN, SC, BLK, GN, PC



Pedestal Post Doorstop Holders

- 5316** (inc. 5133) - Auto
5382 (post only)
> Architectural design with concealed welds
> Great for latching back exterior doors where there is no wall fixing option available on concrete and timber decks and patios
> Standard height 280mm, width 50mm x 50mm
Finishes: BLK, SV, PRL, PC
- 5325** (inc. 5258)
> Can be cut down on request
> Base plate size 90mm x 90mm x 5mm with 4x 8mm fixing holes
Stocked powdercoat finishes include: Black and Silver Pearl

Foot Operated Door Holder

- 5063** 170mm x 34mm
26mm throw
Finishes: AB, BN, PB, SC, UB, BHB, DRB, MAB, MB, NB, OR, RB, SB, USB

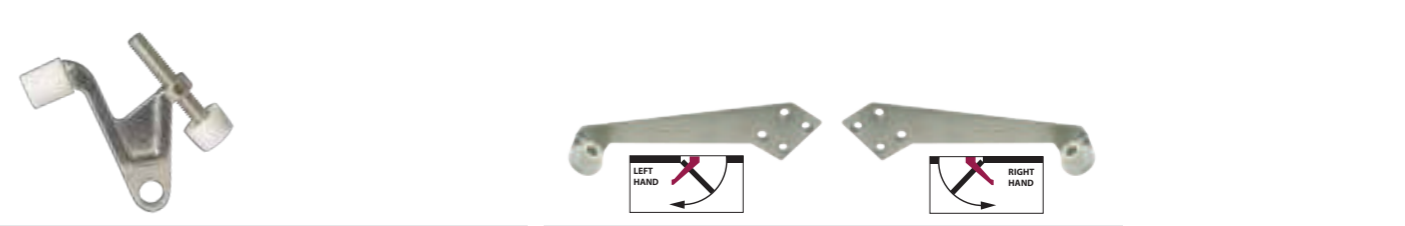

Hinge Pin Adjustable Doorstop

- 5277** Finish as pictured
> Operates from approx. 85°-125° using threaded adjuster
> Can be mounted on any of the door hinges

Overhead Doorstop

- 5263L** 157mm x 46mm
5263R 157mm x 46mm
> Use on doors hung as shown
> Screws to door head jamb
> Angle of operation: minimum 70°, maximum 120°
This is dependent of position on door jamb
Finishes: SS, PC

MAGNETS, DRILL BITS, HINGES & CATCHES



Door Magnets

- 1464** Cup Magnet 25mm Ø × 7mm
- 1262** 22mm Ø × 8mm (pic)
- 1262-5** 22mm Ø × 8mm, 5pk
- 1463** 22mm Ø × 8mm dbl countersunk
- 1180** 25mm Ø × 7mm (pic)
- 1180-5** 25mm Ø × 7mm, 5pk
- 1265** 25mm Ø × 10mm

- > Bumpstop and screws supplied
- > Includes rubber buffers for a soft close
- > Made from N42 grade raw material for superior magnet strength

Magnet Installation Diagram

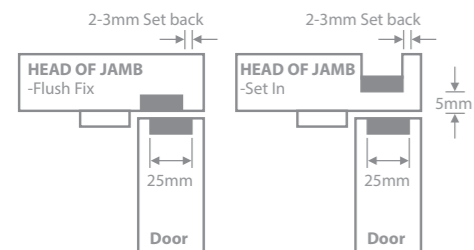

Drill Bits

- 1278** 22mm Forstener Drill Bit
- 1191** 25mm Forstener Drill Bit
- 1448** 48mm Forstener Milling Bit for rapidFIT®

- > For use with Windsor magnets
- > Drills a smooth clean hole
- > The short narrow point won't protrude into jamb like a standard spade



Hinges (other hinges available on request)

- 5901** Loose Pin Flat Tip
- 5903** Fixed Pin Flat Tip (no PC) 101.6mm × 76.2mm
- > Solid Stainless Steel
- > Includes screws



- 5900** Loose Pin Ball Tip
- 5902** Fixed Pin Ball Tip (no PC) 101.6mm × 76.2mm
- > Solid Brass
- > Includes screws



- 5904** Loose Pin 89mm × 60mm
- > Solid Stainless Steel
- > ¼" radius corners
- > Comes with 18mm and 25mm screws

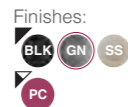

Adaptor Plate

- 1141** Adaptor Plates (Pair) 65mm Ø
- > Designed for Astron only

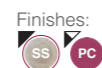

Spindles

- 1167** Split Spindle 7.6mm × 98mm
- 1171** Split Spindle (pic) 7.6mm × 116mm for 52mm+ doors
- > For use with commercial mortice locks



Door Catches

- 1119** Roller Catch
- > "T" Striker included
- > Only strike PC

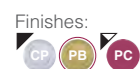

- 5015** Double Ball Catch, 50mm
- 5016** Double Ball Catch, 60mm

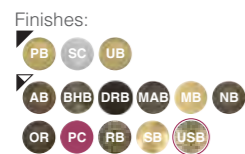

Retrofit Adaptor Roses

- 9062** Screw-on Passage Roses (Pair)
- 9075** Press-on Integrated Privacy Adapter Roses (Pair)
- > 65mm Ø × 10mm screw-on adaptor plate
- > Designed for Futura and Galaxy round rose only (excluding Talon)
- > Use for 54mm hole pattern

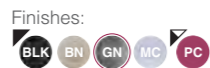

Dummy Fixing Mounts

- 1137** 7.6mm Spindle 26mm Ø base
- 1152** 8mm Spindle 32mm Ø base

FLUSH BOLTS & REVERSE BARREL BOLTS

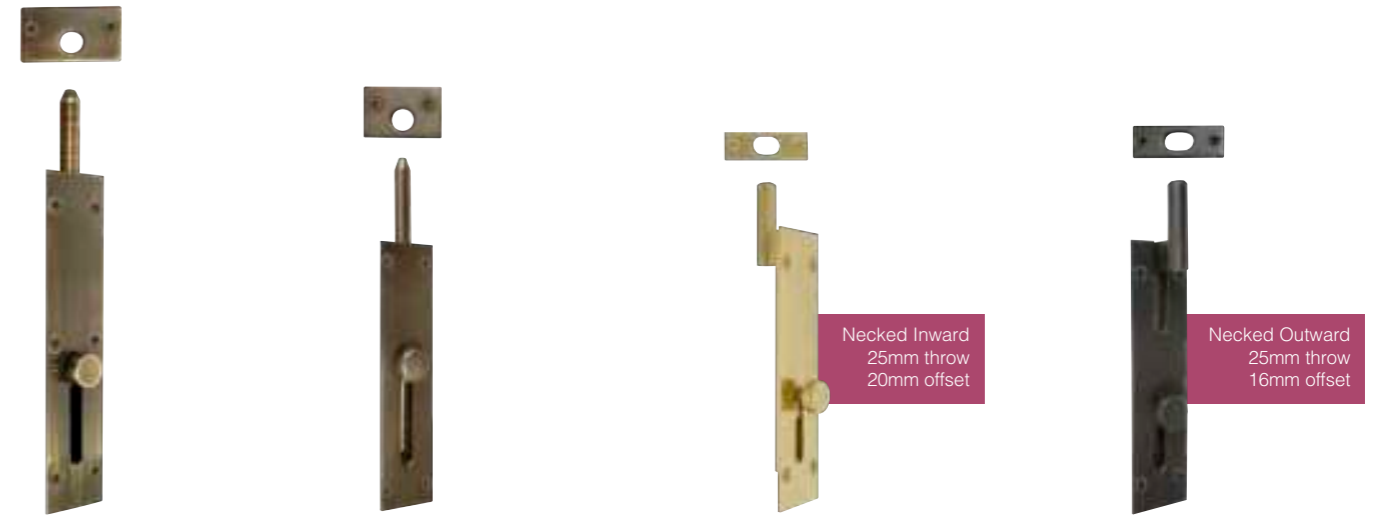

Reverse Barrel Bolts

- 5225** Straight Throw 150mm × 31mm 9.6mm pin 40mm throw
- 5226** Straight Throw 100mm × 25mm 7.6mm pin 35mm throw
- 5270** Necked Throw (pic) 125mm × 31mm
- 5271** Necked Throw 150mm × 31mm
- 5272** Necked Throw (pic) 125mm × 31mm
- 5273** Necked Throw 150mm × 31mm

Finishes:

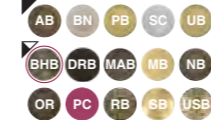

Finishes:



Finishes:



Finishes:

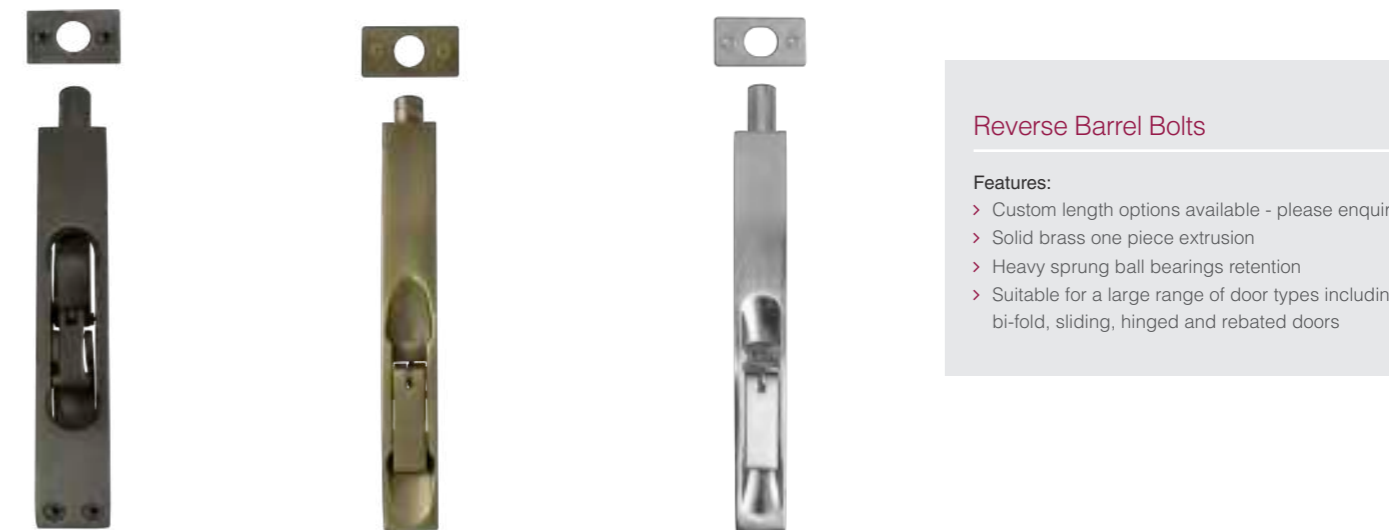
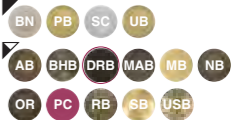

Flush Bolts

- 5308** Straight Throw Heavy Duty 149mm × 20mm 151mm × 25mm 12mm bolt 18mm throw
- 5028** Straight Throw 149mm × 20mm 11mm bolt 15mm throw
- 5235** Economy 152mm × 19mm 11mm bolt 18mm throw
- > Zinc die-cast

Finishes:

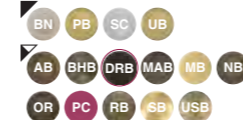

Finishes:

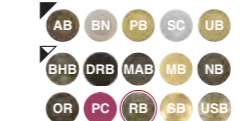

Finishes:



Reverse Barrel Bolts

Features:

- > Custom length options available - please enquire
- > Solid brass one piece extrusion
- > Heavy sprung ball bearings retention
- > Suitable for a large range of door types including bi-fold, sliding, hinged and rebated doors



Commercial Straight Bolt

5346 Socket bolt - standard throw

5378 Socket bolt - with swivel

150mm x 38mm

- > 12mm bolt provides great strength in commercial situations
- > Solid Brass construction, strong housing – built to last
- > Dual ball bearings provide a firm but smooth action
- > 30mm bolt throw

Finishes:



Straight Barrel Bolts

code	mm dimensions	mm throw
5215	35 x 25	15
5207	50 x 25	20
5208	75 x 25	20
5209	100 x 25	20
5210	150 x 31	50 (long throw)
5224	150 x 31	30 (standard throw)

(5210 - CP, PB, SC only)

- > Front keepers included
- > Heavy sprung ball bearings retention
- > One-piece extrusion

Finishes:

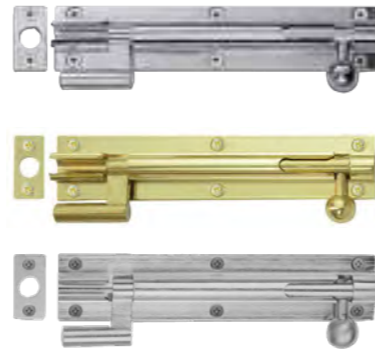

Necked Barrel Bolts

code	mm dimensions	mm throw
5211	50 x 25	11
5212	75 x 25	19
5213	100 x 25	19
5214	150 x 31	25

- > Front keepers included
- > Heavy sprung ball bearings retention
- > One-piece extrusion

Finishes:



Brass Pull Handle & Push Plate

5038

235mm x 45mm

Finishes:



5059

205mm x 50mm



Knockers

3034

210mm x 95mm

Finishes:



4016

205mm x 100mm



Door Viewer

5243 180° Door Viewer

> Suits 34mm – 52mm doors

Finishes:

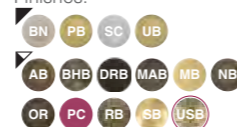

Escutcheons

5135 Single

34mm Ø

Finishes:

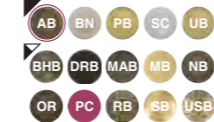

5051 Single

34mm Ø

Finishes:



8003 Standard Lock pair

8003E Euro pair (pic)

8003O Oval pair

45mm Ø x 10mm

Finishes:



7020E Euro pair (pic)

7020O Oval pair

55mm Ø x 11mm

Finishes:



Escutcheons

8189 Euro pair

8189O Oval pair

50mm Ø x 8mm

Finishes:

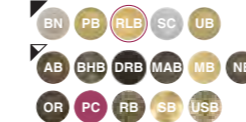

8420 NIDO Euro pair

56mm Ø x 6mm

Finishes:



8102E Euro pair (pic)

8102O Oval pair

55mm square x 11mm

Finishes:



9035 Euro round pair

54mm Ø x 10mm

9045 Euro square pair (pic)

54mm square x 10mm

Finishes:



Escutcheons

8146E Euro pair

60mm x 30mm

Finishes:

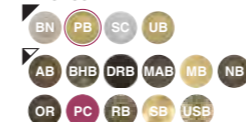

Cabin Hooks

code	mm o/a	engaged opening mm
5144	75	95
5142	100	120
5057	125	145
5143	150	185
5275	200	235
5276	250	290

Finishes:

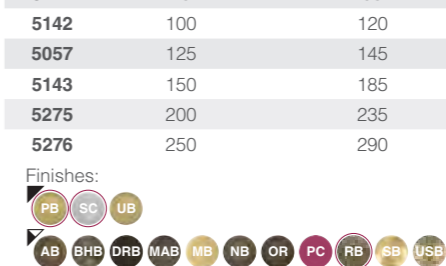



Cavity Suite Privacy Kit Square
Matt Black



Galaxy Pegasus - Privacy Set
Graphite Nickel



Flush Pull 128mm
Brushed Nickel
Sliding Door Edge Pull
Stainless Steel



Sliding Door Kit
Antique Bronze



PRIVACY & SLIDING DOOR

Flush Pulls 158mm
Matt Black
Square Edge Pull
Matt Black



Double Turn Sets

9072
54mm Ø roses
8mm spindle

Finishes:



9073
54mm square roses
8mm spindle

Finishes:



Double Turn Sets

8118
50mm Ø roses
8mm spindle
Now available in all special finishes

Finishes:



8147
60mm x 30mm roses
8mm spindle
Now available in all special finishes

Finishes:



Single Turns with Flat Tail-Bar

7067
55mm Ø rose

> For use with commercial Mortice Locks

Finishes:



8113
55mm square rose

Finishes:



8104
50mm Ø rose

Finishes:

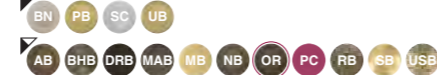

Mini Lever Sets

9076
54mm Ø roses
8mm spindle

Finishes:



9077
54mm square roses
8mm spindle

Finishes:



Privacy Sets

7032
60mm b/s bolt
54mm Ø roses
5mm spindle

Finishes:



9034
60mm b/s bolt
54mm Ø roses
5mm spindle

Finishes:



9044
60mm b/s bolt
54mm square roses
5mm spindle

Finishes:



Privacy Sets

5198
60mm b/s bolt
26.5mm Ø roses
5mm spindle

Finishes:



8087
57mm b/s bolt
50mm Ø roses
5mm spindle

Finishes:



7076 Indicator
60mm b/s bolt
52.5mm Ø roses
6mm spindle

Finishes:



Privacy Sets

7072
60mm b/s bolt
55mm Ø roses
5mm spindle

Finishes:



8101
60mm b/s bolt
55mm square roses
5mm spindle

Finishes:





Privacy Sets

8400 NIDO Privacy Set
57mm b/s bolt
56mm Ø rose
5mm spindle

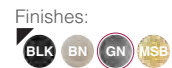

8410 NIDO Privacy Set - Knurled
57mm b/s bolt
56mm Ø rose
5mm spindle

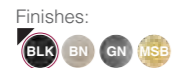

Turn & Escape on Rose

8408 NIDO Turn & Escape
56mm Ø rose
5mm spindle

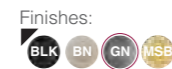

8409 NIDO Turn & Escape - Knurled
56mm Ø rose
5mm spindle

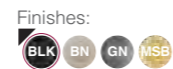

Turn & Escape on Rose

7071
55mm Ø roses
5mm spindle

> Bolt not included

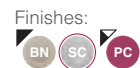

8188
50mm Ø roses
5mm spindle

> Bolt not included



5192
26.5mm Ø roses
5mm spindle

> Bolt not included



Turn & Escape

8055
5mm spindle

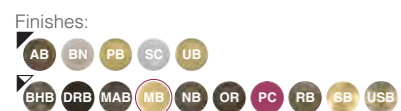

Indicator Turns

8041
5mm spindle



8042
50mm Ø roses
5mm spindle



Edge Pulls

5329 Cavity Sliding Edge Pull
29mm Ø
> 25mm hole pattern for install

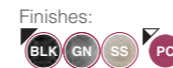

5333 Cavity Sliding Edge Pull
29mm x 29mm
> 25mm hole pattern for install

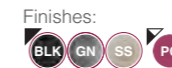

Wardrobe Kits

5339 Wardrobe Kit (Round)
65mm Ø

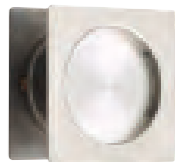

5340 Wardrobe Kit (Square)
65mm square

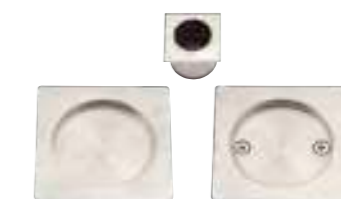

Passage Kits

5326 Cavity Sliding Passage Kit (Round)
65mm Ø

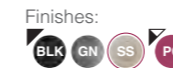

5330 Cavity Sliding Passage Kit (Square)
65mm square

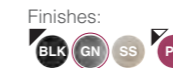

5330 Cavity Sliding Passage Kit (Square)
65mm square

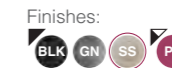

5330 Cavity Sliding Passage Kit (Square)
65mm square

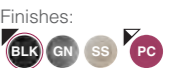

Privacy Kits

5327 Cavity Sliding Privacy Kit
65mm Ø
> Use on bathroom doors

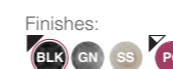

5331 Cavity Sliding Privacy Kit
65mm square
> Use on bathroom doors

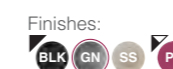

Latching Kits

5328 Cavity Sliding Double Turn
65mm Ø
60mm b/s bolt
> Use on interconnecting rooms



5332 Cavity Sliding Double Turn
65mm square
60mm b/s bolt
> Use on interconnecting rooms

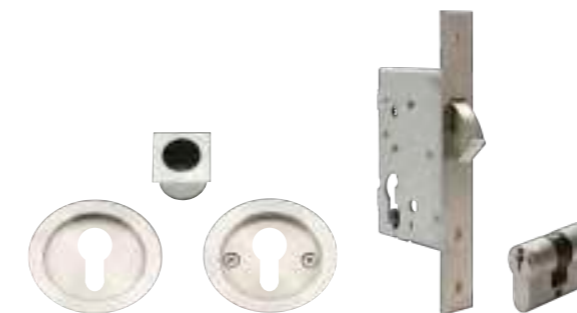
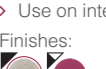

Locking Kits

5335 Cavity Sliding Locking Kit (Round)
65mm Ø
50mm b/s



Includes:
> 2 Euro punched Flush Pulls,
1179 Sliding Door Lock, 38mm
Euro Cylinder & 5333 Edge Pull
> Minimum door thickness 40mm



5336 Cavity Sliding Locking Kit (Square)
65mm square
50mm b/s

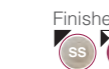

Includes:
> 2 Euro punched Flush Pulls,
1179 Sliding Door Lock, 38mm
Euro Cylinder & 5333 Edge Pull
> Minimum door thickness 40mm



Flush Pulls

code	mm	crs
5317/BB	126 x 42	96
5318/BB	158 x 42	128
5319/BB	190 x 42	160

- > Back to back sets only available in BN, SC & PC
- > Back to back Flush Pulls suit door thicknesses from 32mm – 38mm



Brass Flush Pull & Edge Pull

8105 Flush Pull (Single) 55mm Ø x 11mm (AB & UB 14 day lead time)	8088 Door Edge Pull 29mm Ø > 24mm hole pattern for install
--	---



Stainless Flush Pulls

5228 120mm x 40mm	5257 128mm x 83mm	5241 120mm x 40mm	5242 102mm x 51mm
-----------------------------	-----------------------------	-----------------------------	-----------------------------



Brass Flush Pulls

5040 Flush Pull (Single) 125mm x 45mm > Solid brass	8079 Sliding Door Kit 120mm x 34mm	8141 Flush Pull (Single) 120mm x 34mm
--	--	---



Flush Pull Kit

8107 29mm Ø Edge Pull 55mm Ø x 11mm Flush Pull



Flush Rings

code	mm
5177	40 x 33
5154	50 x 37
5155	63 x 50



code	mm
5304	200 x 37
5305	250 x 37
5306	300 x 37



Flush Pull Kits

5260 Oval 120mm x 40mm > Includes: 2x Flush Pulls and 100mm x 20mm Edge Pull	5261 Square 102mm x 51mm > Includes: 2x Flush Pulls and 100mm x 20mm Edge Pull
---	---



5320 (pic) 200mm x 37mm	5321 250mm x 37mm	5322 300mm x 37mm > Includes: 2x Flush Pulls and 100mm x 20mm Edge Pull
-----------------------------------	-----------------------------	--



Privacy Kit

8106 Privacy Kit > Includes: Turn, Escape, Edge Pull and 50mm backset Privacy Mortise Lock > Suits 36mm+ doors > Countersunk Flush Pulls allow doors to fully recess inside cavity
--



Euro Lock Kits

1188 Oval Style 120mm x 40mm	1189 Square Style 102mm x 51mm	1269 (pic) 200mm x 37mm	1270 250mm x 37mm	1271 300mm x 37mm
--	--	-----------------------------------	-----------------------------	-----------------------------

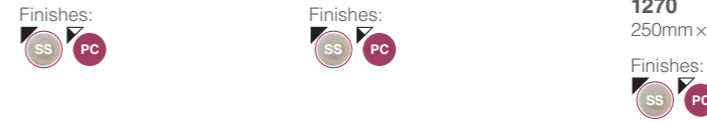

Euro Lock Kits

- Includes:
 - > 2 Euro punched Flush Pulls, 1179 Sliding Door Lock, 38mm Euro Cylinder & 100mm x 20mm Edge Pull
 - > Minimum door thickness 40mm



> For Flush Pull cropping dimensions, please refer to windsorhardware.co.nz/installation



Vulcan Window Fastener
Satin Chrome



Spur Fastener
Satin Chrome



Casement Fastener
Satin Brass

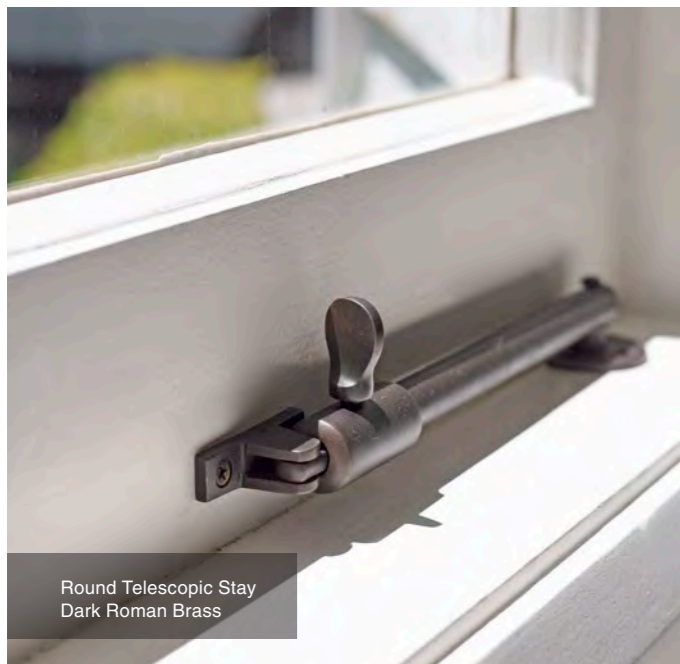

Round Telescopic Stay
Dark Roman Brass

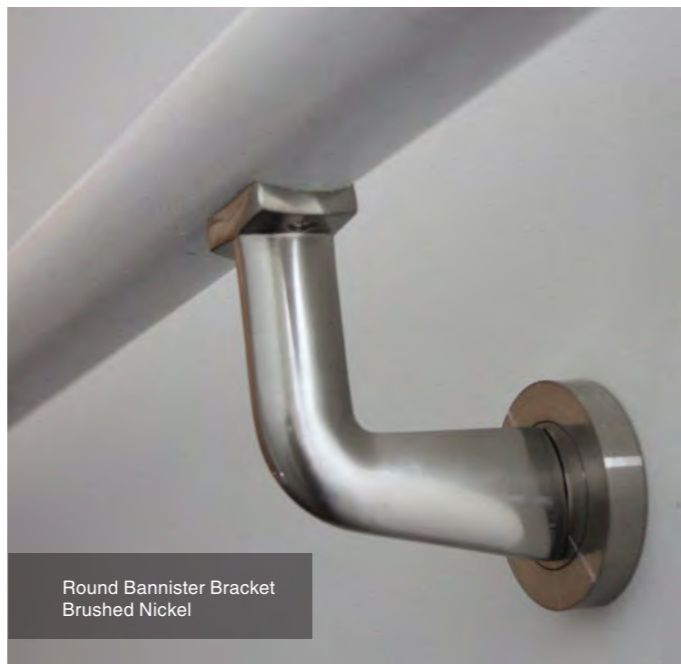

Round Bannister Bracket
Brushed Nickel



WINDOW FITTINGS, HOOKS & BANNISTER BRACKETS

Square Telescopic Stay
Satin Chrome

WINDOW STAYS

Our fanlight, casement and quadrant stays are now offered in new and improved designs.

They now all suit windows with and without weather seals, are available in new sizes to suit a wider range of applications and have a heavier duty construction and pivot points.



Fanlight Stays

5385
300mm

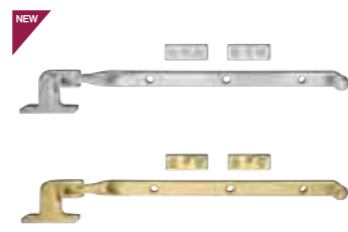

5185
250mm

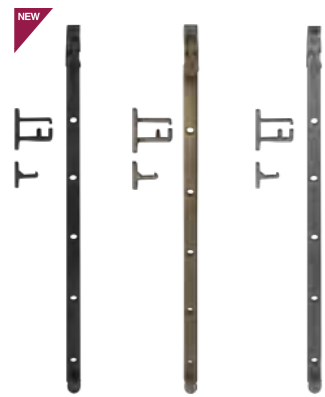

Casement Stays

5184
350mm

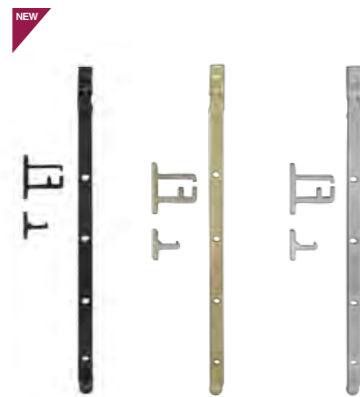

5384
300mm



Quadrant Stay

5086

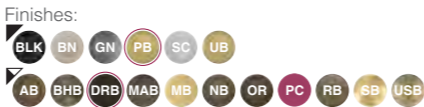

Telescopic Stays

5205 Round
240mm – 375mm



5354 Square
240mm – 375mm



WINDOW STAYS & FASTENERS



Restrictor Stays

5355 Round
140mm – 180mm

> Ideal for use on windows to restrict opening to meet building standard



5356 Square
140mm – 180mm

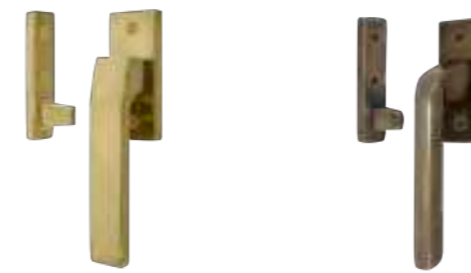

Window Fasteners

5343 Qube Window Fastener
31mm overall protrusion

> Narrow 31mm overall protrusion enables this fastener to fit behind vertical blinds and wooden louvers (Qube design)
> Suits timber windows with or without weather seals
> Can be mounted on top hung or side hung windows



5344 Vulcan Window Fastener
44mm overall protrusion



Wedge Fasteners

5386 Traditional Wedge Fastener

> Suits timber windows with or without weather seals
> Can be mounted on top hung or side hung windows

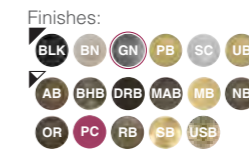

5323 Wedge Fastener

> Suits timber windows with or without weather seals
> Can be mounted on top hung or side hung windows



Casement Fasteners

5136 Teardrop



5187 Square

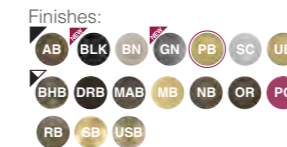

5324 Casement Fastener
5324-WS Casement Fastener to suit weather seals



Split Rail Fastener

5195 L Split Rail Fastener
5195 R Split Rail Fastener

> Not suitable where weather seals are used
> Can be mounted on top hung or side hung windows

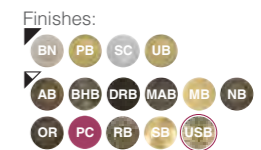



Hat, Coat & Robe Hooks

- 5250**
5297 3 pack
> Aluminium
(3 packs available only in BN & SA)
Finishes:
- 5196** Single
Finishes:
- 5236** Double
Finishes:
- 3024**
110mm x 31mm
Finishes:
- 2017**
> Black Iron
Finishes:



Sash Fasteners

- 5025** Sash Fastener
> Narrow 15mm profile keeper
Finishes:
- 5060** Spur Fastener
Finishes:
- 5269** 6mm Packer
For 5060 spur fastener
> To suit hardware being fitted to new timber windows with rubber draught seals
Finishes:



Sash Lifts

- 5026** Hook
50mm x 25mm
30mm pj
Finishes:
- 5053**
40mm x 15mm
30mm pj
Finishes:
- 5360** Hook
39mm x 12mm
23mm pj
Finishes:

Spring Catches

- 5194** Standard
> Includes extended keeper to suit weather seal windows and doors
> Standard size keepers also available
> Solid brass construction
> Other lengths available to order - please enquire
Finishes:
- 5361** 300mm
- 5362** 450mm



Bannister Brackets

- 5140** Flat Mount 60mm
> Made from solid brass
> Strong, concealed fixings
> Simple lag screw that can be used with narrow gauged timber framing
Finishes:
- 5153** Flat Mount 75mm
Finishes:
- 5166** Curved Mount 60mm
> Quick and easy to install - simply drill a 5mm hole and wind them in
> Can be supplied with face fixing option - please enquire
Finishes:
- 5167** Curved Mount 75mm
Finishes:



Bannister Brackets & Stanchions

- 5352** Round
> These solid Vulcan/Sigma inspired Bannister Brackets have been designed with your internal door hardware in mind
> Suits 40mm - 50mm diameter rail
> Easy install with concealed fittings
> Flat mount adapter available for both styles (as seen in 5353 pic)
> Design complies with clearances specified in standard NZS/AS 1657:1992
Finishes:
- 5353** Square
- 5170** Flat Mount 50mm to rail
> Strong, solid and aesthetically appealing, these matching Bannister Stanchions are made from a one piece brass casting giving quality, economy and style to add that extra touch
Finishes:
- 5171** Curved Mount 50mm to rail



Cleat Hook

- 5092**
76mm x 23mm
Finishes:

Pulley

- 5197**
122mm x 25mm
Finishes:

Pulls

- 5190**
100mm o/a, 86 mm crs
Finishes:
- 5191** (pic)
125mm o/a, 111 crs
Finishes:



Minerva
Matt Black



Marco
Brushed Nickel



Streamline
Graphite Nickel



Basketweave
Burnished Iron



CABINET HANDLES

Streamline
Matt Black



Minerva

code	mm crs	mm o/a
6413	96	126
6314	128	158
6414	160	190
6315	192	222
6316	288	318
6415	448	478

15mm wide
34mm pj
Finishes:
BLK BN GN SA PC

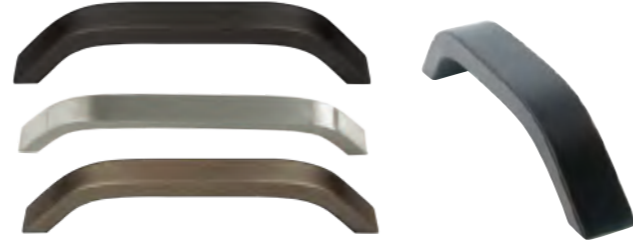

Streamline

code	mm crs	mm o/a
6484	128	142
6485	160	174
6487	256	270
6489	320	334
6490	448	462
6491	640	654

19mm wide
32mm pj
(6491 is only available in BN and PC)
Finishes:
BLK BN GN PC



Marco

code	mm crs	mm o/a
6336	96	122
6337	128	157
6338	160	193
6339	192	225
6340	240	273
6382	320	356

8mm wide
25.5mm pj
(6382 28mm pj)
Finishes:
BN PC



Polo

code	mm crs	mm o/a	mm width
6333	128	158	19
6334	160	192	21
6335	192	226	24

25mm pj
Finishes:
BN PC



Pakello

code	mm crs	mm o/a
6434	128	177
6435	160	209
6436	192	241
6437	288	337
6438	448	497
6439	640	689

10mm wide
32mm pj
Finishes:
BN PC



Verbano Series II

code	mm crs	mm o/a
6492	64	88
6493	128	152
6494	192	216
6495	288	312
6496	448	472

11mm wide
20mm pj
Finishes:
BN PC



Primo

6357	96mm crs 123mm o/a
Finishes:	BN PC

6358	128mm crs 161mm o/a
Finishes:	BN PC



D-Handles

code	mm dimensions
6006	96 x 10
6019	160 x 10
6010	192 x 10

34mm pj
Finishes:
SC PC



Melo

code	mm crs	mm o/a
6426	128	144
6427	160	176
6428	192	208
6429	288	304
6430	448	464
6431	640	656

25mm wide
32mm pj
Finishes:
BN PC



Sincro

code	mm crs	mm o/a
6068	96	104
6069	128	136
6749	160	168
6750	256	264
6751	320	328

12mm wide
27mm pj
(6069 only available in BN and PC)
Finishes:
BN SC PC



Lecco

6077	128mm crs 146mm o/a 20mm wide 28mm pj
Finishes:	SA PC



Designer Bow

6108	160mm crs 193mm o/a 34mm pj
Finishes:	BN PC



6106	96mm crs 130mm o/a 28mm pj
Finishes:	BN PC

6107	128mm crs 162mm o/a 28mm pj
Finishes:	BN PC



Anglo

6345
25mm x 25mm
16mm crs
21mm pj
Finishes:
BN PC



Rialto

6341
39mm x 21mm
16mm crs
20mm pj
Finishes:
BN SC PC



Cup Handles

5018
86mm x 44mm
20mm pj
Finishes:
AB BN PB SC UB
BHB DRB MAB MB NB
OR PC RB SB USB



6729 Concealed fix
80mm x 29mm
27mm pj
Finishes:
AB BLK VP



Handle

2041 Trunk Handle
105mm x 75mm
> Black Iron finish
Finishes:
BLK



Basketweave

6756
200mm crs
215mm o/a
40mm pj
Finishes:
BI



6755
128mm crs
142mm o/a
40mm pj
Finishes:
BI



6781
90mm x 30mm
Finishes:
BI



Knobs

6061 Cone Knob
22mm Ø
21mm pj
Finishes:
BN PC



6062 Cone Knob
28mm Ø
26mm pj
Finishes:
BN PC



6149 Lip Pull
52mm
18mm pj
Finishes:
BN PC



6088
25mm Ø
31mm pj
Finishes:
SA PC



6737
33mm Ø
25mm pj
Finishes:
AB BLK VP



Minerva

code	mm crs	mm o/a	mm pj
7170	224	254	36
7171	288	318	36

- > Recommended for interior use only
- > Ideal for use on double doors between lounge and dining rooms
- > Constructed from aluminium

Finishes:
BN SC PC



Melo

code	mm crs	mm o/a	mm pj
7173	224	240	33
7174	288	304	33

- > Recommended for interior use only
- > Ideal for use on double doors between lounge and dining rooms
- > Constructed from aluminium

Finishes:
BN SC PC



Black Iron Knobs

code	mm Ø	mm pj
2037	25	27
2038	30	30
2039	38	39
2040	50	45

Finishes:
BLK



Solid Brass Knobs

6200
25mm Ø
19mm pj

Finishes:

AB BN PB SC UB BHB DRB MAB MB NB OR PC RB SB USB

6201
30mm Ø
23mm pj

6202
38mm Ø
27mm pj



DOOR CLOSERS



303 2-4 strength, adjustable power by position

- 303-7-1 Hold Open Pull Side Screw Arm inc. Cover *Available in SC & PC*
- 303-7-0 Hold Open Pull Side Screw Arm exc. Cover *Available in SC*
- 303-3-1 Flat Bar Arm inc. Cover *Available in BN, SC & PC*
- 303-3-0 Flat Bar Arm exc. Cover *Available in SC*

303-3-1 shown in BN

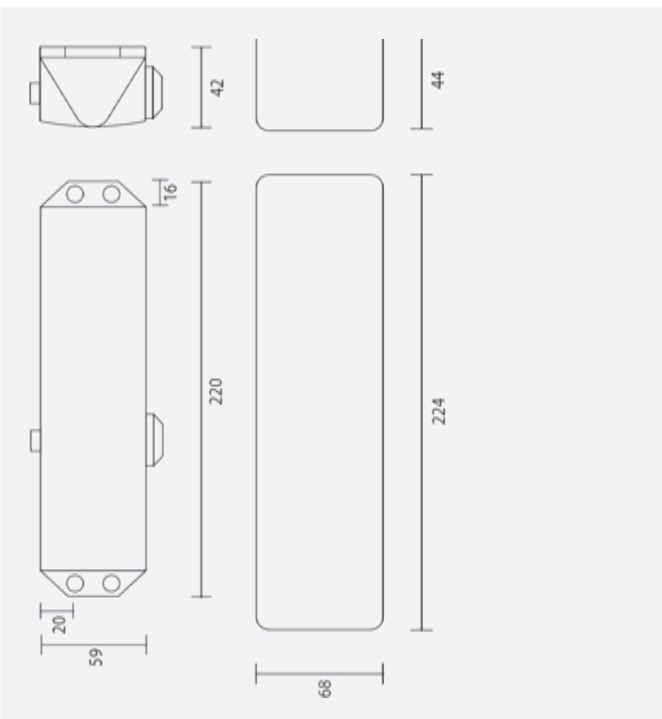

- Adjustable Closing Speed
- Adjustable Latch Speed
- Max Door Weight 60kg
- Max Door Width 930mm
- Opening Angle 180°
- Power Size EN2-4
- Universal Application



324 2-4 strength, adjustable power by spring

- 324-7-2 Hold Open Pull Side Screw Arm inc. Cover *Available in SC & PC*
- 324-7-0 Hold Open Pull Side Screw Arm exc. Cover *Available in SC*
- 324-3-2 Flat Bar Arm inc. Cover *Available in BN, SC & PC*
- 324-3-0 Flat Bar Arm exc. Cover *Available in SC*

324-3-2 shown SC

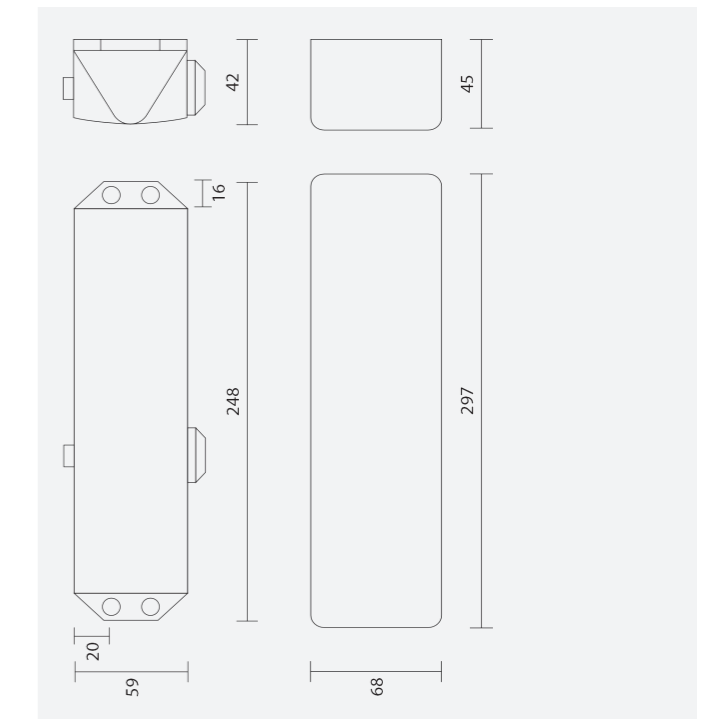

- Adjustable Closing Speed
- Adjustable Latch Speed
- Max Door Weight 80kg
- Max Door Width 1100mm
- Fire Rated
Refer fire door manufacturer for approval
- Opening Angle 180°
- Power Size EN2-4
- Back Check
- Universal Application



526 Door Closer and Drop Plate
Satin Chrome



525 2-5 strength, adjustable power by spring

- 525-2-3 Screw Arm inc. Cover *Available in SC & PC*
- 525-2-0 Screw Arm exc. Cover *Available in SC*
- 525-8-3 Hold Open Pull Side Screw Arm inc. Cover *Available in SC & PC*
- 525-8-0 Hold Open Pull Side Screw Arm exc. Cover *Available in SC*
- 525-9-3 Hold Open Push Side Screw Arm inc. Cover *Available in SC & PC*
- 525-9-0 Hold Open Push Side Screw Arm exc. Cover *Available in SC*
- 525-3-3 Flat Bar Arm inc. Cover *Available in BN, SC & PC*
- 525-3-0 Flat Bar Arm exc. Cover *Available in SC*
- 525-5-3 Slide Arm inc. Cover *Available in BN, SC & PC*
- 525-5-0 Slide Arm exc. Cover *Available in SC*
- 525-6-3 Hold Open Slide Arm inc. Cover *Available in BN, SC & PC*
- 525-6-0 Hold Open Slide Arm exc. Cover *Available in SC*

525-3-3 shown in SC

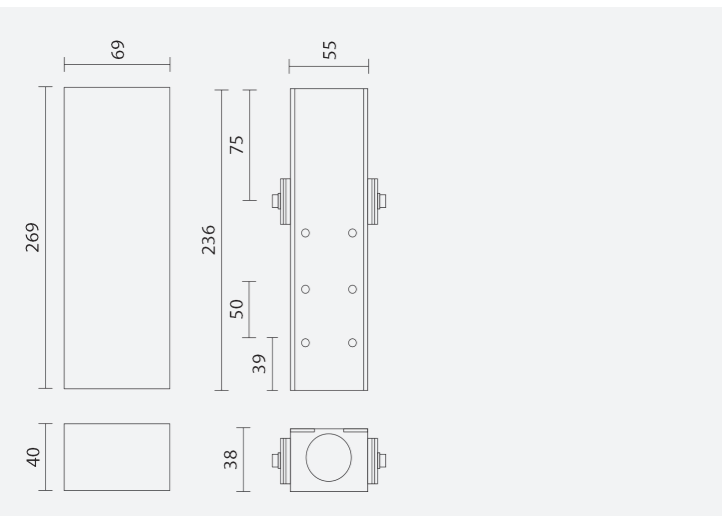

526 2-6 strength, adjustable power by spring

- 526-2-4 Screw Arm inc. Cover *Available in SC & PC*
- 526-2-0 Screw Arm exc. Cover *Available in SC*
- 526-8-4 Hold Open Pull Side Screw Arm inc. Cover *Available in SC & PC*
- 526-8-0 Hold Open Pull Side Screw Arm exc. Cover *Available in SC*
- 526-9-4 Hold Open Push Side Screw Arm inc. Cover *Available in SC & PC*
- 526-9-0 Hold Open Push Side Screw Arm exc. Cover *Available in SC*
- 526-4-4 Flat Bar Arm inc. Cover *Available in BN, SC & PC*
- 526-4-0 Flat Bar Arm exc. Cover *Available in SC*
- 526-5-4 Slide Arm inc. Cover *Available in BN, SC & PC*
- 526-6-4 Hold Open Slide Arm inc. Cover *Available in BN, SC & PC*
- 526-6-0 Hold Open Slide Arm exc. Cover *Available in SC*

526-4-4 shown in SC

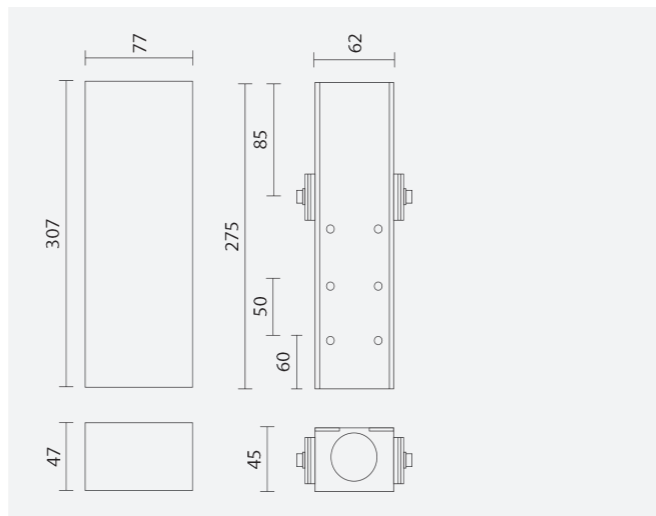

724 2-4 strength, adjustable power by spring

- 724-10-5 Slide Arm inc. Cover & Cushion Stop *Available in BN, SC & PC*
- 724-10-0 Slide Arm exc. Cover & Cushion Stop *Available in SC*
- 724-11-5 Hold Open Slide Arm inc. Cover *Available in BN, SC & PC*
- 724-11-0 Hold Open Slide Arm exc. Cover *Available in SC*

> Cam action closer for ease of opening 724-10-5 shown in SC

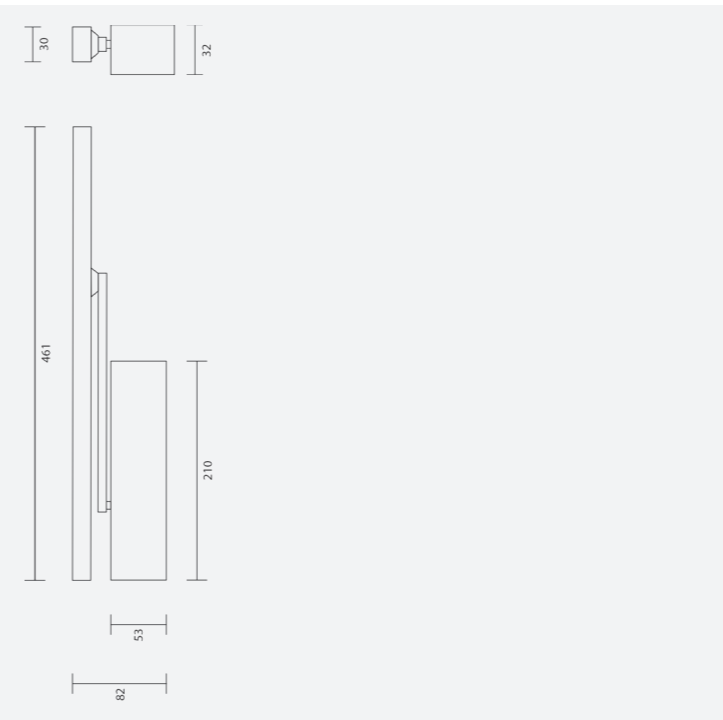

Drop Plates

- 901 To suit 525 Closer
- 902 To suit 526 Closer (pic)



Adjustable Closing Speed	Adjustable Latch Speed	Max Door Weight 110kg	Power Size EN2-5	Adjustable Delayed Action
Opening Angle 180°	Adjustable Back Check	Universal Application	Max Door Width 1250mm	Fire Rated <small>Refer fire door manufacturer for approval</small>

Adjustable Closing Speed	Adjustable Latch Speed	Max Door Weight 120kg	Power Size EN2-6	Opening Angle 180°
Adjustable Back Check	Universal Application	Max Door Width 1400mm	Adjustable Delayed Action	Fire Rated <small>Refer fire door manufacturer for approval</small>

Adjustable Closing Speed	Adjustable Latch Speed	Max Door Weight 60kg	Max Door Width 950mm
Opening Angle 120°	Power Size EN2-4	Universal Application	Fire Rated <small>Refer fire door manufacturer for approval</small>



Invisible Pro



Pivotica Pro



Invisible NEO



NEW

INVISIBLE HINGES & PIVOT CLOSERS



Invisible NEO

Taking minimalism and clean lines to a new level. The ARLU range of Invisible and Pivot Hinges offer new concealed opening and closing systems.

Pivot Hinges are mounted top and bottom to provide a swivel opening action on doors up to 150kg.

Invisible Hinges are completely unseen when the door is closed and an architecturally designed look when the door is open.

Invisible Hinges

FEATURES AND BENEFITS

- > Universal: for left and right-opening doors
- > 180° opening angle
- > "Easy-hook": installation and adjustment by one person
- > Open and shutting movement cycle tests (min. 200,000)

Pivot Hinges

FEATURES AND BENEFITS

- > Easy installation
- > Opening angle in both directions up to 150°
- > Fixed settings at 90° in both directions
- > Free choice of rotating position (hinge point)
- > Child-friendly (easy to open)
- > Available for floor-to-ceiling-height doors

Invisible Hinges



Invisible PRO

9810 XS-4
Min Door Thickness 28mm
Up to 50kg doors

- > Simplified adjustability (height and width)
- > Compact dimensions: only 23 mm built-in depth



Invisible NEO

9811 Invisible NEO S-5 (pic)
Min. Door Thickness 33mm
Up to 80kg doors

- > 3D adjustability (height, width, and depth) without taking the door off
- > Extra simplified height adjustment: no wedge required

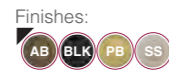

9812 Invisible NEO M-6
Min. Door Thickness 36mm
Up to 100kg doors

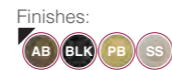

Weight table							
Hinge type	Invisible Pro XS-4		Invisible NEO S-5		Invisible NEO M-6		
Number of hinges	2	3	2	3	2	3	
Max. door weight according to door width	730mm	50kg	65kg	75kg	95kg	95kg	115kg
	830mm	45kg	60kg	70kg	90kg	90kg	110kg
	930mm	40kg	55kg	65kg	85kg	85kg	105kg
	1030mm	35kg	50kg	60kg	80kg	80kg	100kg

Technical features			
Hinge type	Invisible Pro XS-4	Invisible NEO S-5	Invisible NEO M-6
Door thickness	min. 28mm	min. 33mm	min. 36mm
Overall depth	23mm (frame) / 23mm (door)	26.5mm (frame) / 30mm (door)	30mm (frame) / 32mm (door)
Dimensions (L x W)	100mm x 20mm	120mm x 25mm	140mm x 28mm
Height adjustment	-2.5 / +2.5mm	-2.5 / +2.5mm	-3.0 / +3.0mm
Width adjustment	-2.0 / +2.0mm	-3.0 / +4.0mm	-3.0 / +4.0mm

Pivoting Hinges



Pivotica

9800
Spring Loaded
Fixed Positions: Closed, 45° & 90°
20-60kg door



Pivotica Pro

9801 100 - F90 (pic)
Hydraulic Spring
Fixed Positions: Closed & 90°
Up to 100kg door

- > Adjustable bottom plate

9805 150 - F90



Hydraulic Spring
Fixed Positions: Closed & 90°
Up to 150kg door

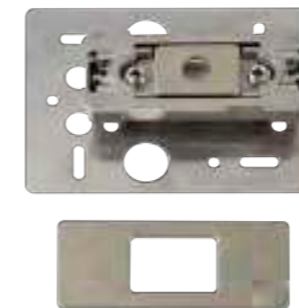

Pivotica Pro Built-In Floor Mount

9804
Built-in mounting part only
Up to 100kg door

- > Designed for use with Pivotica Pro



Pivotica Pro Cover Plates

9803 Pivotica Pro 100 Cover Plates

9807 Pivotica Pro 150 Cover Plates

- > Designed for use with Pivotica Pro

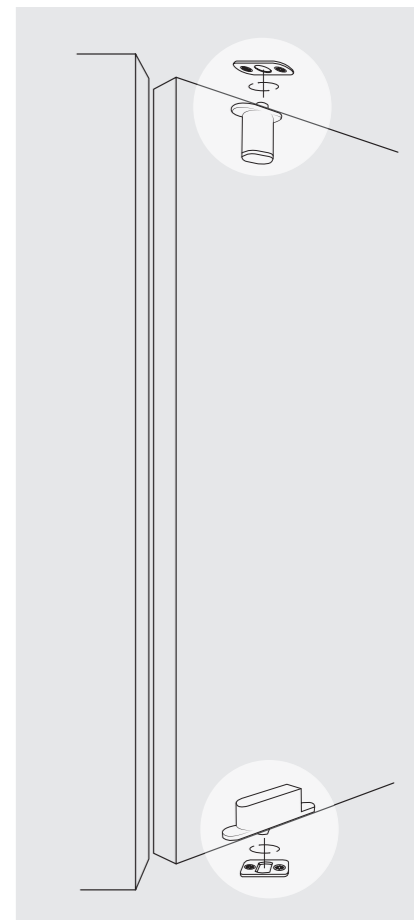

Technical features

Hinge type	Pivotica	Pivotica Pro
Material	Aluminium and Stainless Steel	Aluminium and Stainless Steel
Door thickness	min. 40mm	min. 40mm
Door weight	60kg	max. 150kg
Door width	1500mm	2000mm*
Door height	3000mm	3000mm
Height adjustment	n/a	-3 / +3mm (Adjustable bottom plate)
Width adjustment	n/a	-3 / +3mm (Adjustable bottom plate)
Alignment	n/a	-4 / +4° (Adjustable bottom plate)

* = Central position of the hinge



Traditional Lever Lock - Rebated Euro 48mm
Oil Rubbed Bronze



Double Turn Lock Kit
Brushed Nickel



Futura Apex - Passage Set with
Euro Deadbolt Locking Set
Matt Black



Charleston Round Rose - Passage Set
Rumbled Brass

LOCKS, LATCHES & CYLINDERS



Galaxy Phoenix - Entrance Set
Matt Black

TUBULAR LATCHES



Tubular Latches

1106 45mm b/s, 65mm c/s
1100 57mm b/s, 76mm c/s

Finishes:

1131 60mm b/s, 84mm c/s
 > Plastic recess shield included for tidy installation of strike

Finishes:

1357 60mm b/s
 > Recommended for Futura and Galaxy only

Finishes:

1358 60mm b/s
1359 70mm b/s
 > Recommended for Astron, Futura and Galaxy

Finishes:

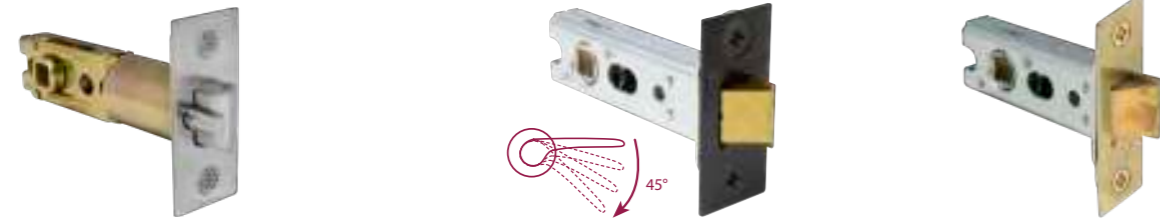

Tubular Latches

1101 70mm b/s, 92mm c/s

Finishes:

Heavy Duty Tubular Latches

1360 60mm b/s, 80mm c/s
 > Dual springing system for extra soft closing action - saves having to slam the door
 > Standard 25mm crop-out

Finishes:

1213 45mm b/s, 67mm c/s (pic)
1172 57mm b/s, 77mm c/s (AB available ex-stock)
1242 83mm b/s, 102mm c/s
 > Double sprung, soft close
 > 25mm Ø mortice
 > Thru-fix on 1172 and 1242

Finishes:



Mortice Latch

1112 57mm b/s, 77mm x 39mm c/s

Finishes:

Night Latch

1215 57mm b/s, 78mm c/s (PC & SS only)
1216 Round Lock Kit with Key/Turn & Escape
1217 Square Lock Kit with Key/Turn & Escape
 > Heavy duty with anti-thrust
 > Use with Windsor Pull Handles or as a combination with lever and escutcheon

Finishes:

Strike & Dust Box

1151 69x45mm
 > Striker for 1131, 1101, 1357, 1358, 1360

Finishes:

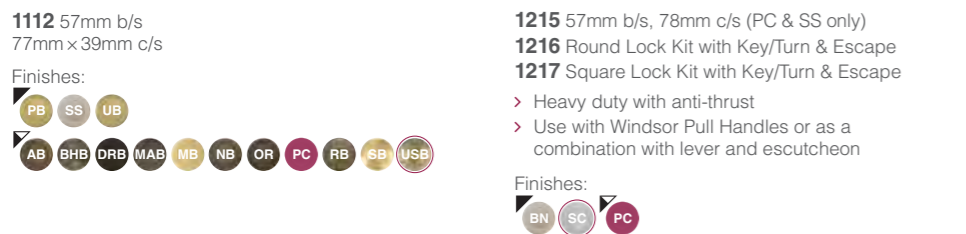

PRIVACY BOLTS, ROLLER CATCH & DEADBOLTS



Privacy Bolts

1203 Tubular, 70mm b/s, 6mm drive

Finishes:

1120 Tubular, 60mm b/s, 5mm drive

Finishes:

1173 Heavy Duty Tubular, 57mm b/s
1243 Heavy Duty Tubular, 83mm b/s

> Thru-fix
 > 25mm Ø Mortice, 5mm drive
 Finishes:

1111 Mortice Bolt, 57mm b/s, 5mm drive

Finishes:



Privacy Bolt

1110 Bathroom Lock/Latch (pic)
 57mm b/s, 78mm c/s, 5mm drive

1136 Bathroom Lock/Latch
 45mm b/s, 65mm c/s, 5mm drive

> Dust box available on request

Finishes:



Slimline Safety Latch

1267 Slimline Safety Latch
1268 Slimline Safety Latch-lockable
 47mm c/s, 60mm x 30mm plates

Finishes:



Roller Catch

1195 Heavy Duty Mortice Roller Catch
 67mm x 62mm c/s
 > Adjustable roller

Finishes:



Deadbolts

1130 45mm b/s, 66mm c/s
1135 57mm b/s, 78mm c/s

> Use with Euro Profile Cylinder and Escutcheons

Finishes:



9011 Key/Key
 Suitable for door thicknesses 34mm – 46mm

> Sold as complete units only
 > Adjustable bolt for 60mm or 70mm backset
 > C4 key profile
 > Supplied with 3 keys

Finishes:



9012 Key/Turn
 Suitable for door thicknesses 34mm – 50mm

> Concealed fix to exterior
 > 65mm Ø casing

Finishes:



MINI LEVER & DOUBLE TURN SETS, LEVER LOCKS & ROLLER LOCKS

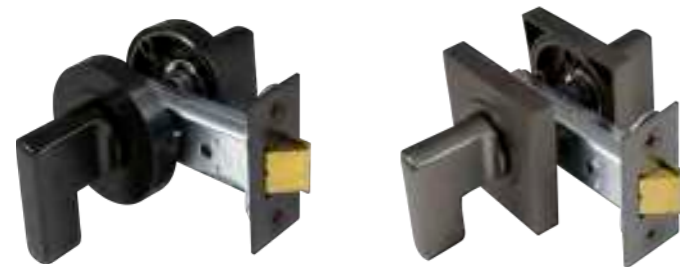

Mini Lever Latch Sets

- 9095** 60mm b/s
54mm Ø roses
- > Heavy duty latch
 - > Thru-fixing
 - > Ideal for use on entry doors with electronic or standard Deadbolts and Pull Handles
- 9096** 60mm b/s
54mm square roses
- > Heavy duty latch
 - > Thru-fixing
 - > Ideal for use on entry doors with electronic or standard Deadbolts and Pull Handles

Finishes:

BLK BN GN SC SS PC

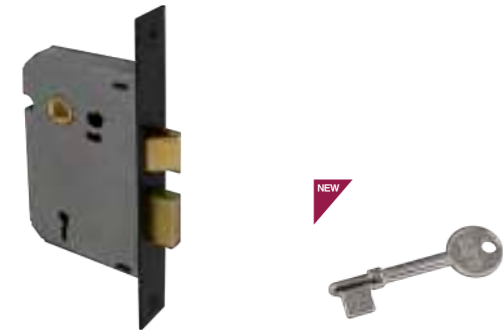

Double Turn Latch Sets

- 8120** 45mm b/s
8121 57mm b/s
54mm Ø roses
8mm spindle
- Finishes:
- BLK BN SC SS PC
- 8123** 45mm b/s
8124 57mm b/s
54mm square roses
8mm spindle
- Finishes:
- BLK BN SC PC

Finishes:

BLK BN GN SC SS PC



Three Lever Locks

- 1107** 45mm b/s, 65mm c/s
1108 57mm b/s, 78mm c/s
- > Economy with medium security
 - > 100 key differs
 - > Includes two keys
- 1117** Three Lever Key Blank (pic)
1117L Three Lever Key Blank 1-50
1117R Three Lever Key Blank 51-99
1117EL Three Lever Key Blank
1117ER Three Lever Key Blank
- > Key blanks for added convenience of extra keys
 - > If key has a stamped "E" use 1117EL and 1117ER

Finishes:

PC AB BLK CP PB PC



Five Lever Locks

- 1103** 45mm b/s, 66mm c/s
1104 57mm b/s, 78mm c/s
- > Rugged construction
 - > Anti-saw rollers for high security
 - > Includes two keys
 - > Available keyed alike
- 1118** Five Lever Key Blank

Finishes:

AB PVD SS UB BHB DRB MAB MB NB OR PC RB SB USB



Roller Locks

- 1139** Heavy Duty 45mm b/s, 65mm c/s
1140 Heavy Duty 57mm b/s, 76mm c/s
- > Adjustable roller
- 1156** 57mm b/s, 78mm c/s (PC & SS only) (pic)
1149 Lock Kit Round Key/Key
1150 Lock Kit Round Key/Turn
1157 Lock Kit Round Key/Turn
- > Features forend roller adjustment

Finishes:

PB SC UB
AB BHB DRB MAB MB NB
OR PC RB SB USB



Finishes:

BN SC PC

Sliding Door Locks

- 1279** Heavy Duty Euro Lock
57mm b/s
78mm c/s
- 1179** Euro Lockcase
50mm b/s

Finishes:

PB SC UB
AB BHB DRB MAB MB NB OR PC RB SB USB



EURO PROFILE LOCKS & CYLINDERS



Euro 48 Profile Locks

- 1114** 45mm b/s, 66mm c/s
1115 57mm b/s, 78mm c/s
1169 Lock Kit (Rebated)
1114+1105+1148
1170 Lock Kit, 1115+1148
- > Suitable for thru-fixing
 - > High security lock
 - > Easi-T quick reversal system for latch

Finishes:

AB BLK BN PB PVD SS UB
BHB DRB MAB MB NB OR PC
RB SB USB

- 1350** 45mm b/s, 66mm c/s
1352 57mm b/s, 78mm c/s
1351 Rebate lock combo
45mm b/s

Finishes:

PC AB PVD SS PC

Euro 85 Profile Locks

- 1226** 30mm b/s, 47mm c/s
(Not available in PB)
1227 35mm b/s, 52mm c/s
- > Latch retracts with cylinder
- 1142** 45mm b/s, 71mm c/s
(Not available in GN)
1143 60mm b/s, 86mm c/s
1143ST 10mm short throw
- > Suitable for thru-fixing
 - > Features two stage bolt throw
 - > 1142 and 1143 have a 20mm throw

Finishes:

PB SS PC AB PC
BLK GN SS PC

- 1402** 45mm b/s, 71mm c/s
1403 60mm b/s, 86mm c/s
- > 1402 and 1403 have a 20mm throw

Finishes:

PB UB
AB BHB DRB MAB MB
NB OR RB SB USB



5 pin Euro Profile Cylinders

- Double Cylinder**
1121 5 pin, 60mm
1147 5 pin, 70mm
(Not available in GN)
- Cylinder Turn**
1122 5 pin, 60mm
(Not available in GN)
1148 5 pin, 70mm

Finishes:

AB BLK BN GN PB SC UB
BHB DRB MAB MB NB OR PC RB SB USB

- Double Cylinder**
1222 5 pin, 80mm
- Cylinder Turn**
1223 5 pin, 80mm

Finishes:

BN PB SC UB
AB BHB DRB MAB MB NB OR PC RB SB USB

- Double Cylinder**
1224 5 pin, 90mm
- Cylinder Turn**
1225 5 pin, 90mm

Finishes:

BN PB SC
AB BHB DRB MAB MB NB OR PC RB SB USB



5 pin Euro Profile Cylinders

- Single Cylinder Key**
1133 5 pin, 30mm
(Not available in GN)
1199 5 pin, 35mm
- Single Cylinder Turn**
1134 30mm
(Not available in GN)
1200 35mm

Finishes:

AB BLK BN GN PB SC UB
BHB DRB MAB MB NB OR PC RB SB USB

6 pin Euro Profile Cylinders

- Double Cylinder**
1246 6 pin, 70mm
- > 6 pin C4 key profile, suits security plugs
 - > Quality Stainless Steel grub screws for quick easy re-keying
 - > Constructed from high quality extruded brass
- Cylinder Turn**
1247 6 pin, 70mm

Finishes:

SC PC

3 pin Euro Cylinder

- Double Cylinder**
1178 3 pin, 38mm

Finishes:

BN PC

KEYLESS ENTRY



NEW

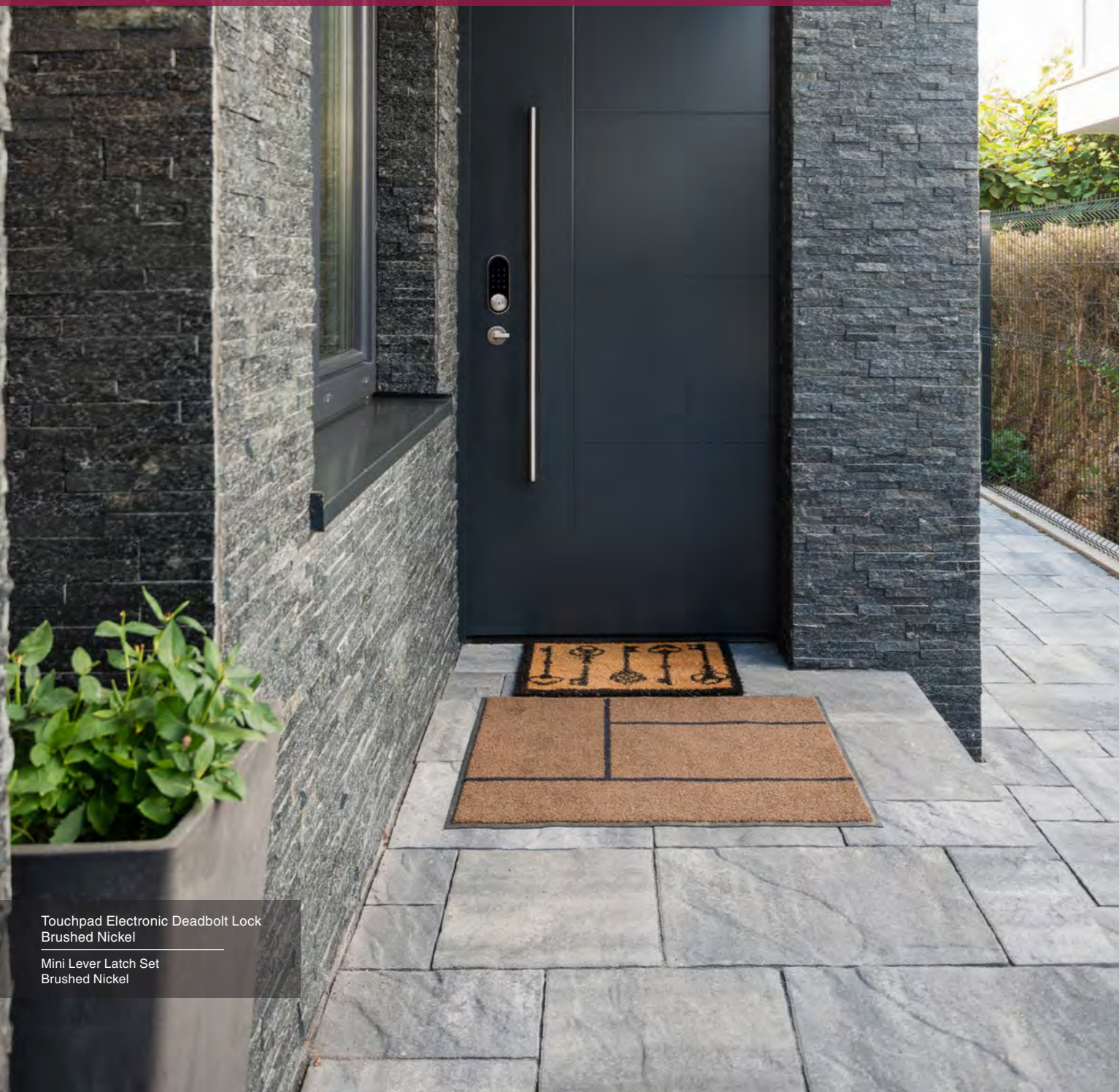

Touchpad Electronic Deadbolt Lock
Brushed Nickel
Mini Lever Latch Set
Brushed Nickel



Touchpad Electronic Deadbolt Lock

1390

Exterior: 133mm x 67mm x 23mm
Interior: 189mm x 73mm x 28mm



Touchpad Electronic Deadbolt Lock

1391

Exterior: 170mm x 68mm x 20mm
Interior: 203mm x 78mm x 33mm



Daily Convenience

- > Bluetooth unlocking capability using a free to download app on your mobile phone
- > Touch to activate, touch to lock, back-up mechanical keyway
- > To unlock use your own mobile phone, code or key
- > Stores up to 30 user codes
- > Can be used in conjunction with lever handles, pull handles or gripsets
- > C4 profile for easy rekeying to the rest of your house
- > Low battery alert

Easy Installation & Programming

- > Minimal tool required for installation
- > Graphic step-by-step installation and programming instructions included
- > How-to-video for installation and programming available on Windsor website
- > Easily retro-fits over standard deadbolt of 54mm hole

Uncompromised Security

- > Anti-tamper function prompts a random code to be entered before your programmed code ensuring fingerprints cannot be easily identified on the touchpad
- > Touch screen is temporarily disabled after four consecutive incorrect entries
- > Temporary user code function – set a code that gets disabled after only one use
- > High security deadbolt with anti-saw protection

Product Specifications

User Codes: Stores up to 30 codes

Programming Code: 4-10 digits

Keys Included: 2

Finishes: Brushed Nickel or Matt Black

Door Bore Hole: 54mm

Door Thickness: 35mm – 51mm

Adjustable Backset: 60mm – 70mm

Touch Screen Back-light Colour: Blue

Power: DC6V (four AA 1.5V alkaline batteries)

Operation Temperature: 0°C – 70°C (battery excluded)

Humidity: 30% – 90% (battery excluded)

International Protection: IP54



bluetooth



code



key

Refer to page 112 for Rebate Kits

STOCKED FINISHES CARE & MAINTENANCE

Stocked Finishes

Stainless Steel

To aid the longevity and appearance of quality Windsor stainless steel products, we suggest cleaning the surface of your hardware periodically with a warm soapy lightly dampened cloth to remove any build-up of dust and grime that may cause corrosion and affect the integrity of the finish. Then simply dry thoroughly with a clean, soft cloth. Minimum of monthly cleaning of door handles is recommended for both finish preservation and general hygiene.

Atmospheric conditions, salt deposits, acids, caustic agents, cement or dust on construction sites all have the potential to cause discolouration to the surface.

If tea staining does occur, to restore your stainless steel product to its original condition, apply a small amount of stainless steel polish onto the cloth and rub the surface along the grain (we recommend 'Blue Magic' – available from Windsor). Rub the affected areas until they are clean and the rust is removed, then wipe off the polish with a clean cloth.

Please avoid using a coarse material to re-brush the finish as this can create inconsistent lines on the product and affect the overall look.

All other stocked finishes

To protect your handles we suggest cleaning the surface of your hardware periodically with a warm soapy lightly dampened cloth to remove any build-up of dust and grime that may cause corrosion and affect the integrity of the finish. Then simply dry thoroughly with a clean, soft cloth. Minimum of monthly cleaning of door handles is recommended for both finish preservation and general hygiene.

If needed, a high-grade chrome polish may be used according to directions to clean and restore the original shine to the chrome finish (Chrome Plated only).

Atmospheric conditions, salt deposits, acids, caustic agents, cement or dust on construction sites all have the potential to cause discolouration to the surface.

Please avoid using any metal polishes, abrasive cleaners, scorers or rough cloths that may damage or scratch the hardware and do not spray or immerse the hardware in liquid to clean.

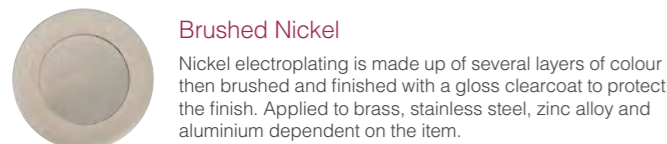

Brushed Nickel

Nickel electroplating is made up of several layers of colour then brushed and finished with a gloss clearcoat to protect the finish. Applied to brass, stainless steel, zinc alloy and aluminium dependent on the item.

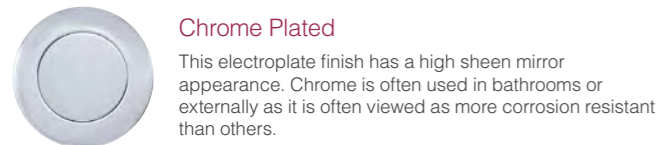

Chrome Plated

This electroplate finish has a high sheen mirror appearance. Chrome is often used in bathrooms or externally as it is often viewed as more corrosion resistant than others.

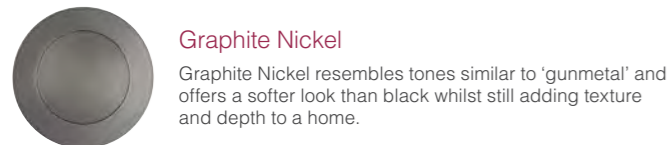

Graphite Nickel

Graphite Nickel resembles tones similar to 'gunmetal' and offers a softer look than black whilst still adding texture and depth to a home.

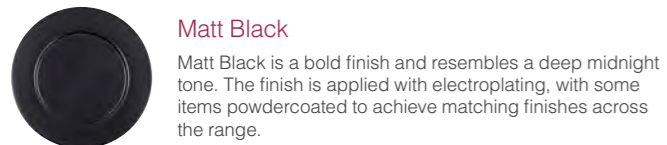

Matt Black

Matt Black is a bold finish and resembles a deep midnight tone. The finish is applied with electroplating, with some items powdercoated to achieve matching finishes across the range.

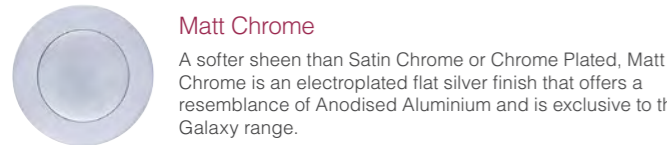

Matt Chrome

A softer sheen than Satin Chrome or Chrome Plated, Matt Chrome is an electroplated flat silver finish that offers a resemblance of Anodised Aluminium and is exclusive to the Galaxy range.

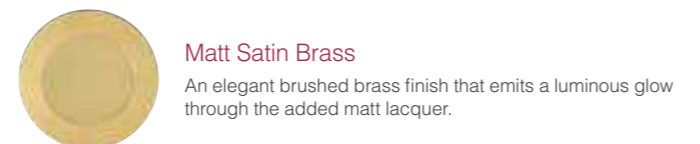

Matt Satin Brass

An elegant brushed brass finish that emits a luminous glow through the added matt lacquer.

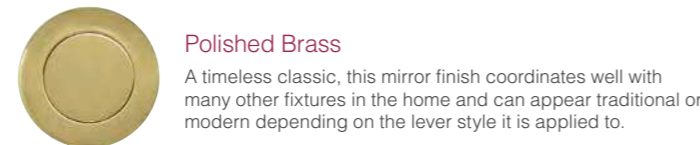

Polished Brass

A timeless classic, this mirror finish coordinates well with many other fixtures in the home and can appear traditional or modern depending on the lever style it is applied to.

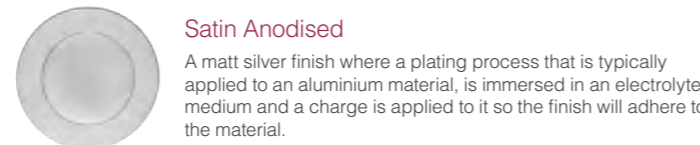

Satin Anodised

A matt silver finish where a plating process that is typically applied to an aluminium material, is immersed in an electrolyte medium and a charge is applied to it so the finish will adhere to the material.

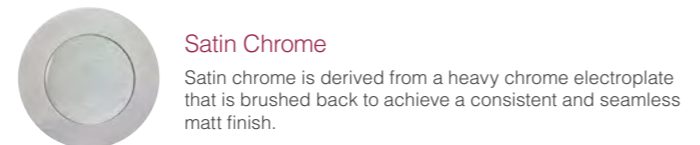

Satin Chrome

Satin chrome is derived from a heavy chrome electroplate that is brushed back to achieve a consistent and seamless matt finish.



Stainless Steel

Stainless steel is a raw material finish, hard wearing and tends to be more resistant to scratching and marking than other finishes. The Windsor stainless steel colour is a consistent brushed look commonly referred to as satin stainless steel.



Stainless Steel Cleaning Kit

5095

Includes:
> Cleaning cloth > Care and maintenance instructions
> Metal polish cream



Wax Polish

5093
50gms



Blue Magic Stainless Polish

5094
100gms



Threadlock

1276
> Medium strength
> Suitable for approx. 20 grubscrews

SPECIAL FINISHES CARE & MAINTENANCE

Special Finishes

This range of handles is constructed from superior solid brass. Forged in Italy they arrive here at Windsor in their raw state to be processed and hand-finished by our in-house team of craftspeople. To create the different finishes, we use a variety of metal treatments, then the finish is relieved-back by hand, creating a series of natural patina finishes. Some finishes are left in their natural state to age over time, this is our living finish range, others are coated with a resin lacquer to protect the colour and provide either a high gloss or matt finish, these are our lacquered finishes. It is recommended that all painting or staining of the doors is completed prior to installation of the door handles.

Living Finishes

The living finishes will naturally patina over time with general use. As with all living and aging finishes, it is recommended to clean the surface periodically with a damp soapy cloth to remove any build up of dust and grime that may cause corrosion and affect the integrity of the finish.

Matt Brass and Unlacquered Brass finishes can be further protected by using the Windsor wax polish occasionally, rubbing this lightly over the surface will provide a layer of protection for extended finish longevity.

Oil Rubbed Bronze and Roman Brass (including DRB) can both be preserved by gently applying a thin oil layer to the surface from time to time. Wipe a thin layer of olive oil (or similar) over the handle then with a clean cloth wipe again to remove any excess on the surface.

Lacquered Finishes

The finishes with a lacquer are recommended to be kept free of dust and grime to prevent any chance of these particles affecting the integrity of the lacquer and potentially causing breakdown or discolouration. We suggest these are wiped and cleaned periodically using a mild window cleaner and damp cloth. Gloss Lacquered finishes may get some light surface scratches appearing with normal wear and tear, for this we recommend using the Windsor wax polish occasionally, rubbing this lightly over the affected area to will provide a layer of protection for extended finish longevity.

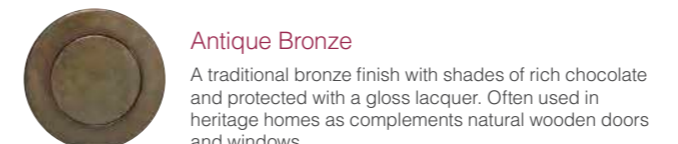

Antique Bronze

A traditional bronze finish with shades of rich chocolate and protected with a gloss lacquer. Often used in heritage homes as complements natural wooden doors and windows.

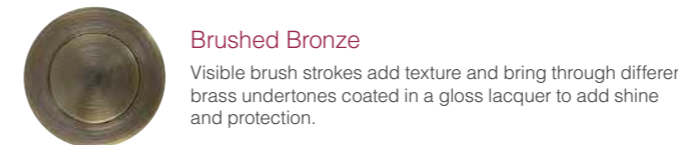

Brushed Bronze

Visible brush strokes add texture and bring through different brass undertones coated in a gloss lacquer to add shine and protection.

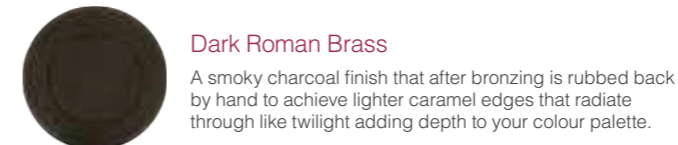

Dark Roman Brass

A smoky charcoal finish that after bronzing is rubbed back by hand to achieve lighter caramel edges that radiate through like twilight adding depth to your colour palette.

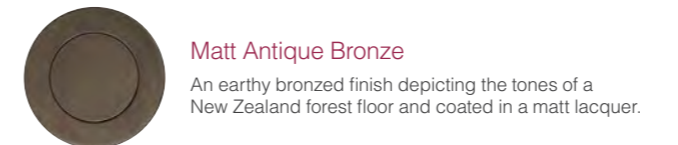

Matt Antique Bronze

An earthy bronzed finish depicting the tones of a New Zealand forest floor and coated in a matt lacquer.

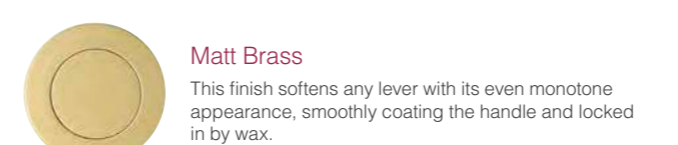

Matt Brass

This finish softens any lever with its even monotone appearance, smoothly coating the handle and locked in by wax.

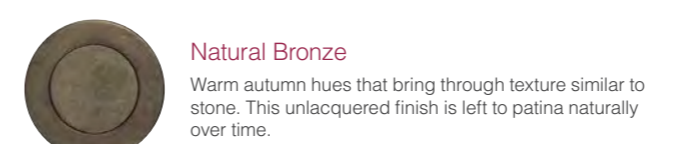

Natural Bronze

Warm autumn hues that bring through texture similar to stone. This unlacquered finish is left to patina naturally over time.

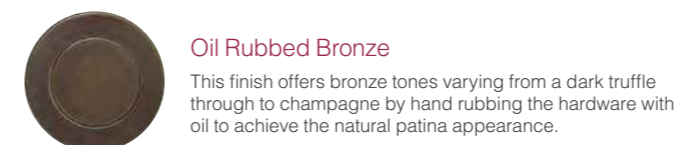

Oil Rubbed Bronze

This finish offers bronze tones varying from a dark truffle through to champagne by hand rubbing the hardware with oil to achieve the natural patina appearance.

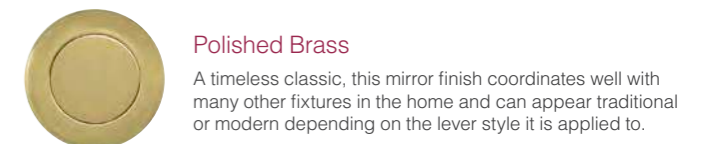

Polished Brass

A timeless classic, this mirror finish coordinates well with many other fixtures in the home and can appear traditional or modern depending on the lever style it is applied to.

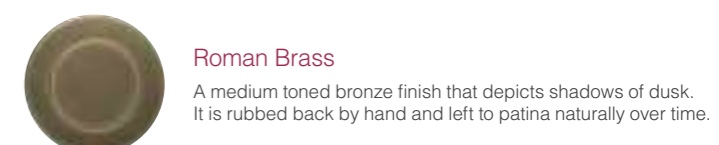

Roman Brass

A medium toned bronze finish that depicts shadows of dusk. It is rubbed back by hand and left to patina naturally over time.

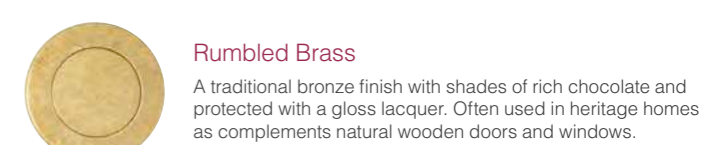

Rumbled Brass

A traditional bronze finish with shades of rich chocolate and protected with a gloss lacquer. Often used in heritage homes as complements natural wooden doors and windows.

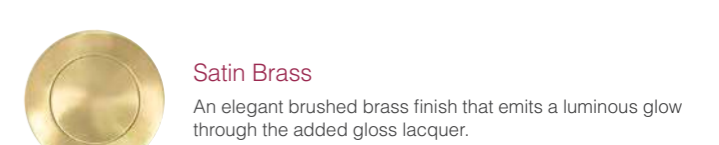

Satin Brass

An elegant brushed brass finish that emits a luminous glow through the added gloss lacquer.

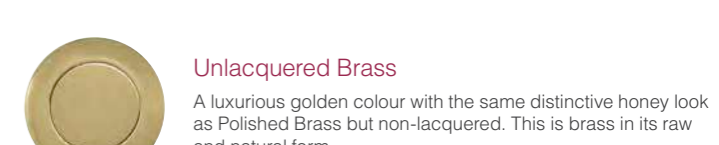

Unlacquered Brass

A luxurious golden colour with the same distinctive honey look as Polished Brass but non-lacquered. This is brass in its raw and natural form.

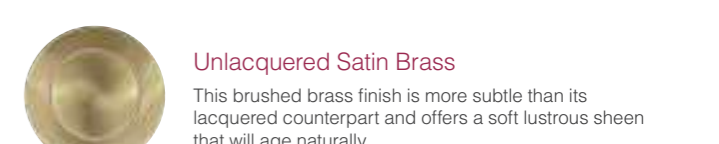

Unlacquered Satin Brass

This brushed brass finish is more subtle than its lacquered counterpart and offers a soft lustrous sheen that will age naturally.

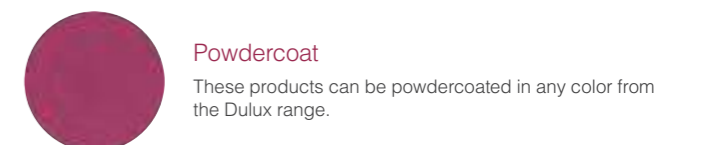

Powdercoat

These products can be powdercoated in any color from the Dulux range.



Rebate Kits

- 1102**
To suit: Tubular Latch
> 47mm length
Finishes: CP, PB, PC, AB, BLK, PC
- 1102A**
To suit: Astron Tubular Latch
> 47mm length
Finishes: SC, PB, UB, AB, BHB, DRB, MAB, MB, NB, OR, PC, RB, SB, USB
- 1105**
To suit: 1103, 1104, 1114, 1115, 1182, 1241
> Full wrap around style for improved aesthetics
> Less vertical clearance between faceplate and striker for a tighter seal
> Available to suit both Euro and 5 Lever Mortice Locks
> To suit standard width door
Finishes: AB, BLK, PB, SS, UB, BHB, DRB, MAB, MB, NB, OR, PC, RB, SB, USB
- 1109**
To suit: 1107, 1108, 1110
> Suits french doors
> Anti-rattle tab on strike to reduce movement
Finishes: PC, AB, BLK, CP, PB, PC
- 1146**
To suit: 1142, 1143
> Suits french doors
Finishes: BLK, SS, PC

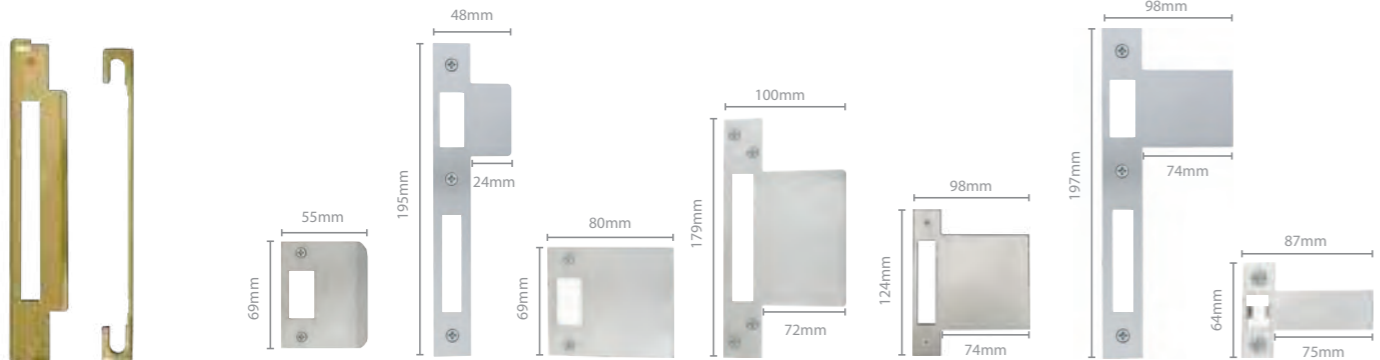

Rebate Kits

- 1404**
To suit: 1402, 1403
> Suits french doors
Finishes: UB, AB, BHB, DRB, MAB, MB, NB, OR, PB, RB, SB, USB

Extended Strikes

- 1301**
> Includes anti-rattle tab
> Maximum measurement stated can be cut to custom length
> 1234 & 1301 available in SS & PC only
Now available in all special finishes
Finishes: SS, PB, UB, AB, BHB, DRB, MAB, MB, NB, OR, PC, RB, SB, USB
- 1234**
LH (pic) or RH
- 1163**
LH (pic) or RH
- 1165**
- 1187**
LH (pic) or RH
- 1209**



Roller Lock Rebate Kit

- 1181** LH or RH (LH pic)
To suit: 1156, 1149, 1150, 1157
> Full wrap around style
> Suits doors 40mm – 50mm thick
> Stainless Steel construction
Finishes: SS, PC



Extended Tongue Rebate Kit

- 1277**
> Suitable for rebated doors 44mm – 56mm in thickness
> Especially suited for use with double glazed doors, where standard 1105 is not wide enough
Finishes: SS, PB, UB, AB, BHB, DRB, MAB, MB, NB, OR, PC, RB, SB, USB



Extended Tongue Rebate Kit

- 1316** LH or RH (LH pic)
> Suits doors 45mm – 55mm thick
> Especially suited for use with double glazed doors, where the standard 1146 rebate kit is not wide enough
> To be used with 85mm centres Euro Locks
Finishes: SS, PB, UB, AB, BHB, DRB, MAB, MB, NB, OR, PC, RB, SB, USB

Lock/Latch	Rebate Kit	Extended Strike	Packer 8mm	Packer 10mm
1100	1102	1163	1210	1211
1101	1102A	1163		
1103/1104	1105	1164	1159	1155
1106	1102	1163	1210	1211
1107/1108	1109	1165		
1110	1109	1165		
1111	1113			
1112	1113	1163		
1114/1115	1105	1164	1159	1155
1120	1240			
1130	1132			
1131	1102A	1163		
1135	1132			
1136	1109	1165		
1139/1140	1144	1162	1158	1154
1142	1146	1187 LH or RH	1186	1185
1143	1146	1187/1234 LH or RH	1186	1185
1156	1181 LH or RH	1162	1161	1160
1172	1174	1163	1210	1211
1173	1174			
1182	1105	1164	1159	1155
1183/1184	1146	1187/1234 LH or RH	1186	1185
1195	1196	1209	1210	1211
1203	1240			
1213	1174	1163	1210	1211
1215	1218 LH or RH	1230	1228	1229
1226/1227	1146	1187/1234 LH or RH	1186	1185
1242	1174	1163	1210	1211
1243	1174			
1248/1249	1146	1187/1234 LH or RH	1186	1185
1250/1251	1146	1187/1234 LH or RH	1186	1185
1258/1259	1146	1187/1234 LH or RH	1186	1185
1267/1268	1146	1187/1234 LH or RH	1186	1185
1279	1280			
1319	1240			
1350	1354	1164		
1352	1354	1164		
1357	1102A	1163	1210	1211
1360	1102A	1163	1210	1211
1390/1391	1240			
1402/1403	1404	1187 LH or RH	1186	1185
9011/9012	1240			
9046	1240/1102A			
9047	1240/1102A			

EXPLODED VIEWS

Passage Sets

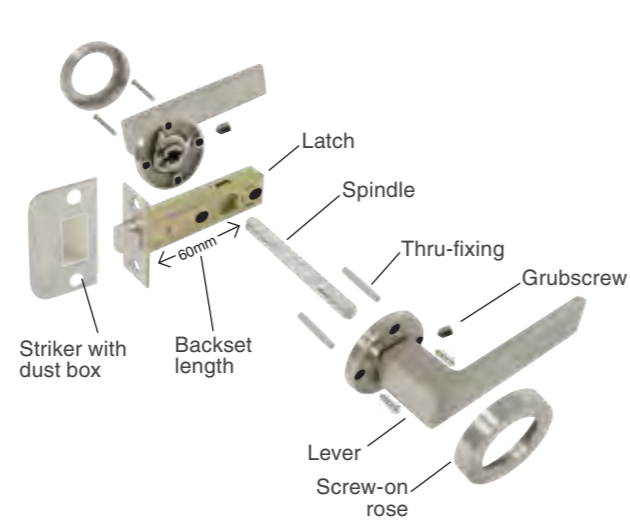
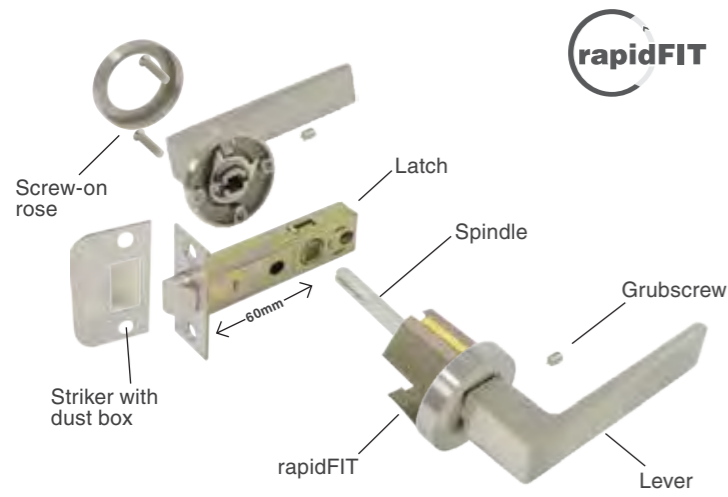

Integrated Privacy Sets

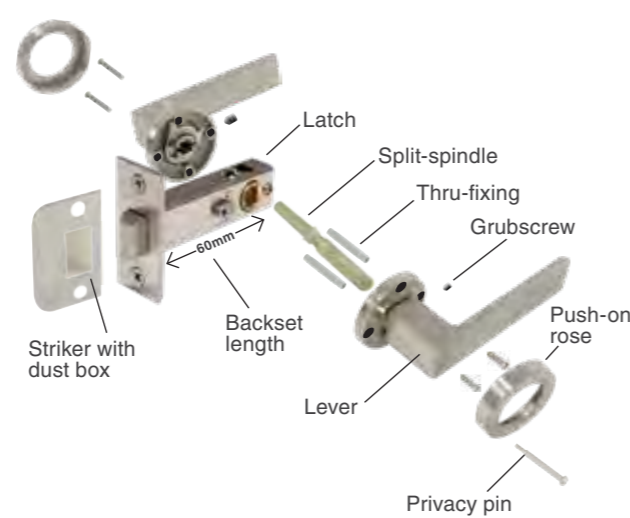
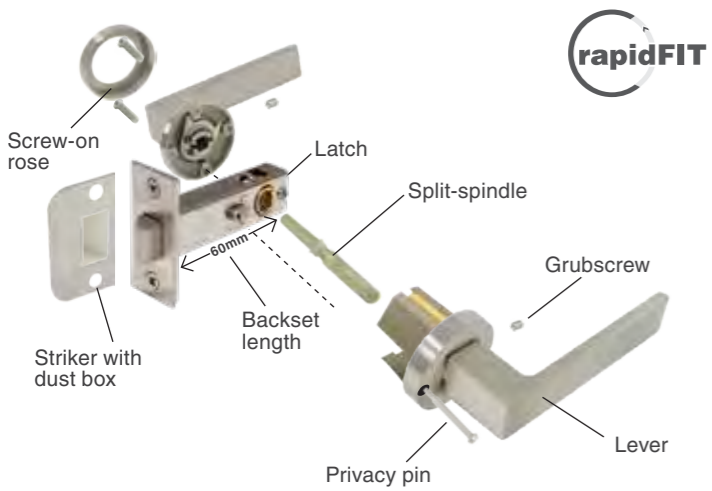

Auxiliary Privacy Bolts

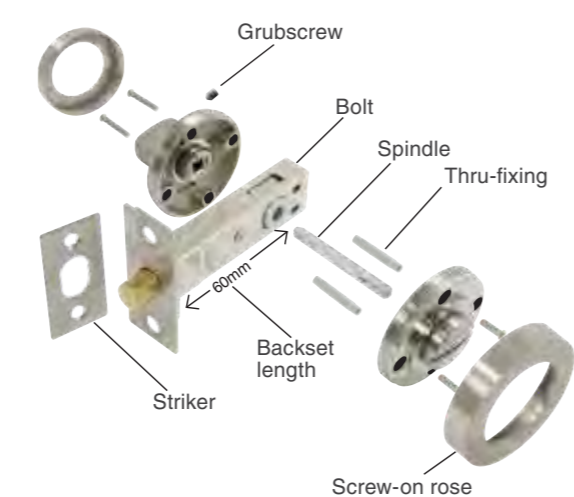
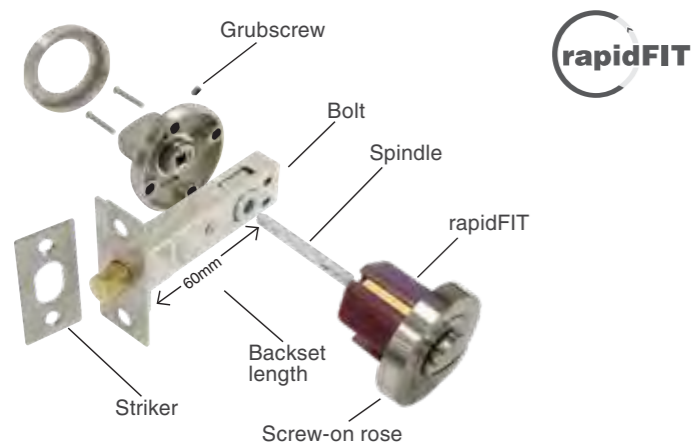

EXPLODED VIEWS & GLOSSARY

Passage Set Halo

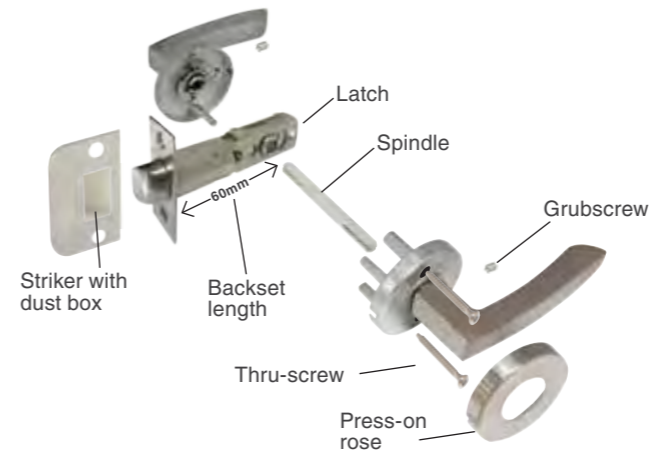

Integrated Privacy Set Halo

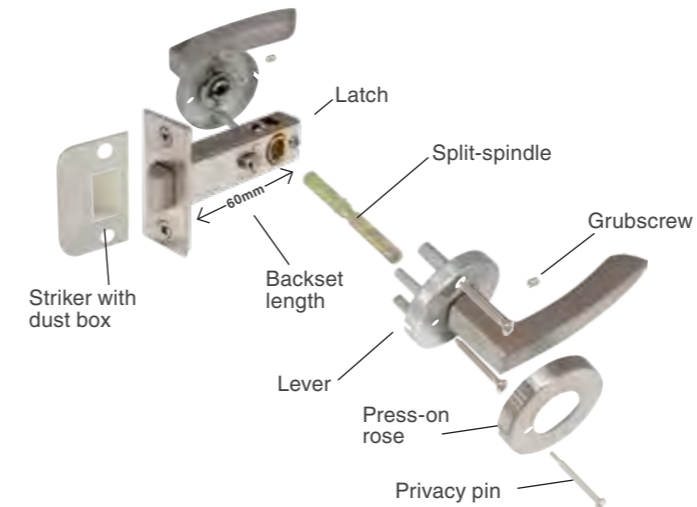

Dummy Lever

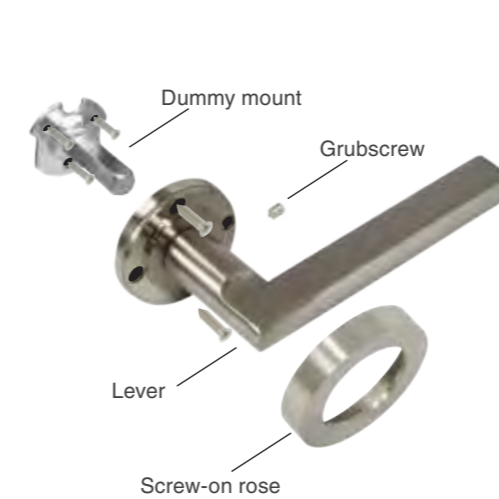

Locking Set

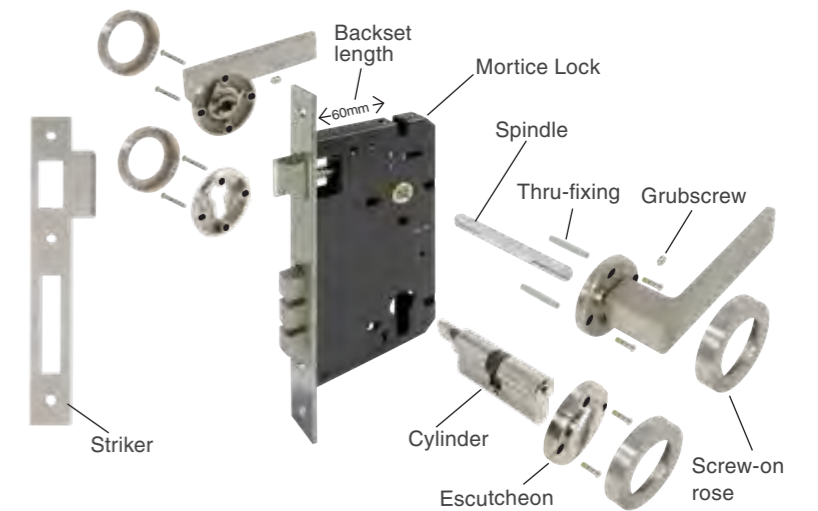

Glossary

- Backset**
Distance from front edge of the door to the centre of the handle spindle hole.
- Cylinder**
A key barrel that is inserted through a mortice lock to drive the locking function. These can be keyed alike to have the same key throughout the house.
- Desprung**
Refers to a lock body or handle that has had the springing tension reduced or removed.
- Dummy Mount**
Small plate with a fixed spindle mounted to it to be used under a dummy handle to prevent it operating on the door.
- Escutcheons**
The housing or decorative plates that are mounted to a door around a cylinder or keyhole to cover up holes made in a door.
- Grubscrew**
Screw that tightens the handle to the spindle.
- Lever**
Refers to the handle part that you grip with your hand.
- Mortice Lock**
The lock body that is inserted into the door, includes both the locking and latching functions in one.
- Handing for Single/Dummy Handles**
- Rebate Kit**
A packer and striker system used between double doors at the point where the latch connects.
- Rose**
Refers to the backplate part the handle mounts to. This encases the springs and point where the screws fix through.
- Auxiliary Privacy Bolt**
Refers to the privacy style where there is a separate turn and release set mounted above or below the handles on the door.
- Spindle**
The shaft that connects to each other through the door between the handles and drives the latch/lock mechanism.
- Striker**
Plate mounted in the door jamb that the door latch closes against.
- Thru-fixing**
Screw fixing that bolt through the door binding the two handles together.
- Tubular Latch**
Refers to a tubular mechanism that is inserted in the door. This is the part that the handles operate to open and close the door.

TYPICAL HARDWARE APPLICATIONS

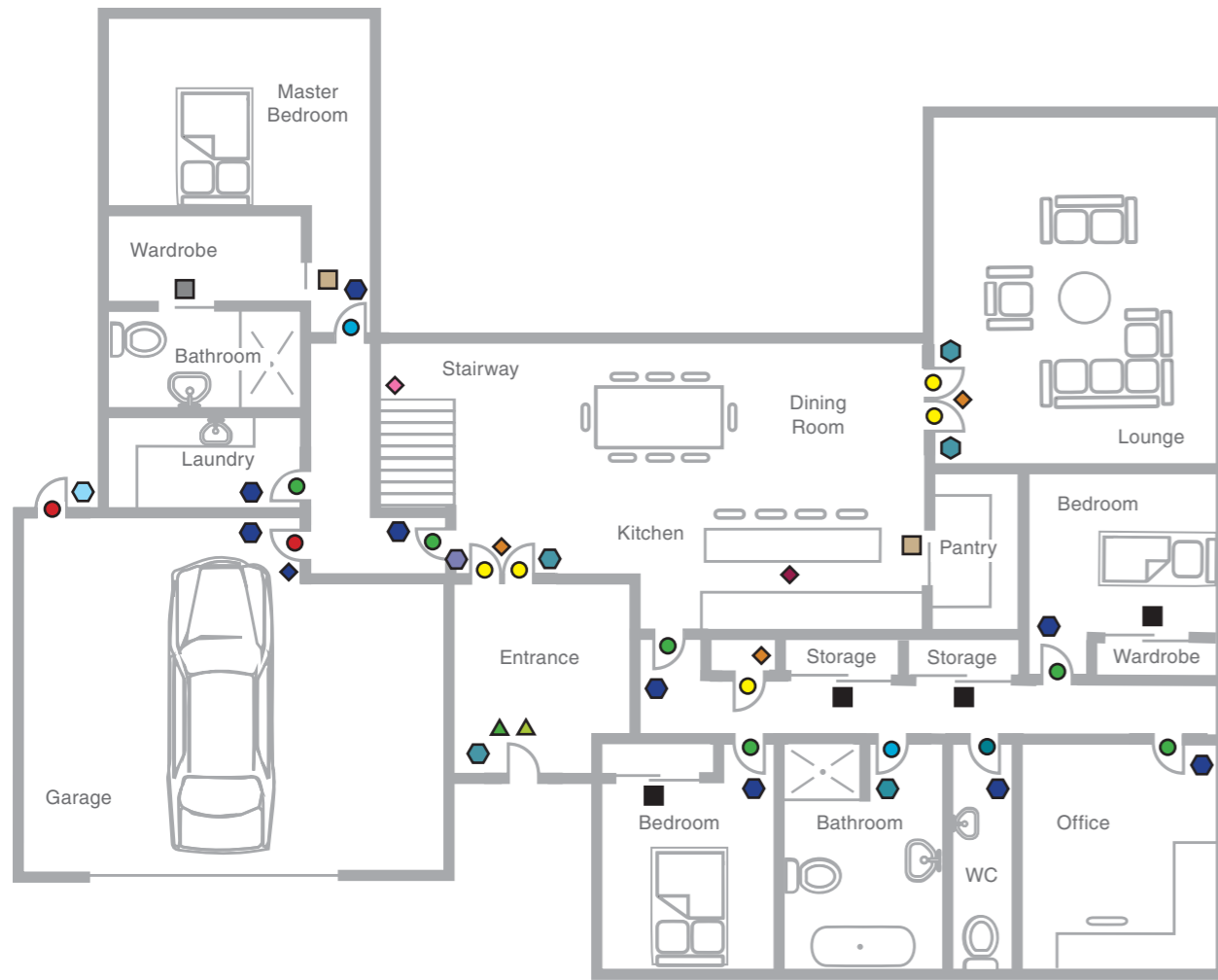

Entrance

- Double Turn Entrance Set
- Pull Handles

Door Furniture

- Passage Set
- Entrance/Locking Set
- Privacy Set
- Dummy Handles
- Integrated Privacy

Sliding Door Hardware

- Cavity Suite - Passage
- Cavity Suite - Privacy
- Flush Pulls



Door Stops

- Skirting Mount Doorstop
- Floor Mount Doorstop
- Overhead Doorstop
- Pedestal Post

Accessories

- Door Closer
- Cabinet Handles
- Magnets
- Stair Rail Brackets

Recommended hinges - see page 68

PRODUCT CODE INDEX

Code	Page	Code	Page	Code	Page	Code	Page	Code	Page	Code	Page	Code	Page	Code	Page	Code	Page
303	95	1221	6	5003	34	5260	81	6335	91	7101	6	7316	47	8190	12	8410	31
324	95	1222	107	5004	34	5261	81	6336	91	7102	6	7317	47	8191	12	8411	26
525	96	1223	107	5005	34	5262	68	6337	91	7103	10	7318	47	8192	12	8412	26
526	96	1224	107	5006	34	5263	69	6338	91	7104	10	7319	47	8193	12	8413	26
724	97	1225	107	5007	34	5264	68	6339	91	7105	42	7320	47	8194	22	8415	26
901	97	1226	107	5015	70	5265	68	6340	91	7106	42	7321	47	8195	23	8420	31
902	97	1227	107	5016	70	5267	81	6341	93	7107	42	7322	47	8196	22	8421	29
1100	104	1228	113	5018	92	5269	86	6345	93	7108	42	7330	47	8197	23	8422	29
1101	104	1229	113	5025	86	5270	71	6357	91	7109	42	7331	47	8201	19	8423	29
1102	112	1230	113	5026	86	5271	71	6358	91	7110	42	7332	47	8202	19	8425	29
1102A	112	1231	7	5028	71	5272	71	6382	91	7112	42	7333	47	8205	19	8431	28
1103	106	1232	7	5038	72	5273	71	6413	90	7113	42	7334	47	8206	19	8432	28
1104	106	1234	112	5040	80	5274	68	6414	90	7114	42	7335	47	8207	19	8433	28
1105	112	1238	9	5051	73	5275	73	6415	90	7115	42	7336	47	8209	19	8435	28
1106	104	1239	10	5053	86	5276	73	6426	90	7116	42	7337	47	8211	20	8441	30
1107	106	1240	113	5057	73	5277	69	6427	90	7117	42	7338	46	8212	20	8442	30
1108	106	1242	104	5059	72	5278	68	6428	90	7119	8	7339	46	8215	20	8443	30
1109	112	1243	105	5060	86	5297	86	6429	90	7120	8	7341	46	8216	20	8445	30
1110	105	1246	107	5062	68	5298	68	6430	90	7121	8	7342	46	8217	20	9005	61
1111	105	1247	107	5063	69	5299	68	6431	90	7122	8	7343	46	8219	20	9006	61
1112	104	1248	15	5069	34	5304	80	6434	90	7123	8	7344	46	8221	18	9007	61
1113	113	1249	15	5070	34	5305	80	6435	90	7124	8	7345	46	8222	18	9008	61
1114	107	1250	15	5071	34	5306	80	6436	90	7128	9	7346	46	8225	18	9009	61
1115	107	1251	15	5072	34	5307	68	6437	90	7129	9	7347	46	8226	18	9010	61
1117	106	1258	14	5086	84	5308	71	6438	90	7130	9	7348	46	8227	18	9011	105
1118	106	1259	14	5090	68	5309	81	6439	90	7131	9	7349	46	8229	18	9012	105
1119	70	1262	70	5092	87	5315	68	6484	90	7134	10	7350	46	8230	23	9013	61
1120	105	1265	70	5093	110	5316	69	6485	90	7142	8	7351	43	8231	21	9014	61
1121	107	1267	105	5094	110	5317	80	6487	90	7143	8	7352	43	8232	21	9015	61
1122	107	1268	105	5095	110	5318	80	6489	90	7144	8	7353	43	8233	21	9016	61
1130	105	1269	81	5127	34	5319	80	6490	90	7145	8	7354	42	8234	21	9017	61
1131	104	1270	81	5128	34	5320	81	6491	90	7146	8	7355	42	8236	21	9018	54
1132	113	1271	81	5129	34	5321	81	6492	90	7147	8	7356	42	8237	21	9019	54
1133	107	1273	10	5130	34	5322	81	6493	90	7148	42	7361	43	8239	21	9020	54
1134	107	1276	110	5133	69	5323	85	6494	90	7149	42	7362	43	8240	22	9021	54
1135	105	1277	113	5135	73	5324	85	6495	90	7150	42	7363	43	8241	22	9022	54
1136	105	1278	70	5136	85	5325	69	6496	90	7151	42	7364	42	8243	22	9023	54
1137	70	1279	106	5137	34	5326	79	6729	92	7152	42	7365	42	8244	22	9024	54
1139	106	1280	113	5138	35	5327	79	6737	92	7153	42	7366	42	8245	22	9025	54
1140	106	1287	10	5139	35	5328	79	6749	90	7154	10	8003	73	8246	22	9026	55
1141	70	1301	112	5140	87	5329	79	6750	90	7159	8	8041	78	8247	22	9027	55
1142	107	1316	113	5142	73	5330	79	6751	90	7160	8	8042	78	8248	22	9028	55
1143	107	1326	6	5143	73	5331	79	6755	93	7161	8	8048	34	8249	22	9029	55
1144	113	1350	107	5144	73	5332	79	6756	93	7162	8	8049	34	8250	22	9030	54
1146	112	1351	107	5149	34	5333	79	6781	93	7163	8	8055	78	8251	22	9031	54
1147	107	1352	107	5153	87	5335	79	7005	35	7164	8	8079	80	8252	22	9032	54
1148	107	1357	104	5154	80	5336	79	7006	35	7165	11	8087	77	8253	22	9033	54
1149	106	1358	104	5155	80	5339	79	7007	35	7166	11	8088	80	8254	22	9034	77
1150	106	1360	104	5157	35	5340	79	7008	35	7167	11	8090	39	8255	22	9035	73
1151	104	1364	15	5158	35	5341	68	7010	35	7168	11	8091	38	8256	23	9036	55
1152	70	1365	15	5166	87	5342	68	7011	35	7170	93	8099	38	8257	23	9037	55
1154	113	1366	6	5167	87	5343	85	7012	35	7171	93	8100	38	8259	23	9038	55
1155	113	1367	6	5170	87	5344	85	7013	35	7173	93	8101	38	8260	23	9039	55
1156	106	1368	10	5171	87	5346	72	7015	43	7174	93	8102	38	8261	23	9040	55
1157	106	1369	9	5177	80	5352	87	7019	43	7181	9	8103	39	8262	23	9041	55
1158	113	1370	7	5179	34	5353	87	7020	73	7182	9	8104	76	8263	23	9042	55
1159	113	1371	7	5184	84	5354	84	7025	7	7183	9	8105	80	8264	23	9043	55
1160	113	1373	6	5185	84	5355	85	7026	7	7184	11	8106	81	8265	23	9044	77
1161	113	1374	6	5186	68	5356	85	7027	8	7185	11	8107	80	8266	23	9045	73
1162	112	1390	109	5187	85	5357	69	7028	8	7187	6	8109	38	8267	23	9046	11
1163	112	1391	109	5190	87	5360	86	7032	77	7188	6	8110	38	8268	23	9047	11
1164	112	1402	107	5191	87	5361	86	7033	43	7189	6	8113	76	8269	23	9051	54
1165	112	1403	107	5192	78	5362	86	7034	43	7190	6	8114	38	8270	23	9052	54
1167	70	1404	112	5194	86	5363	80	7035	43	7191	43	8115	38	8271	19	9053	55
1169	107	1448	70	5195	85	5364	80	7036	43	7192	43	8118	76	8272	19	9054	54
1170	107	1463	70	5196	86	5378	72	7037	43	7195	43	8120	106	8273	19	9055	55
1171	70	1464	70	5197	87	5382	69	7038	43	7196	42	8121	106	8274	19	9056	55
1172	104	2017	86	5198	77	5384	84	7045	43	7197	42	8123	106	8275	18	9062	70
1173	105	2025	11	5205	84	5385	84	7046	43	7198	42	8124	106	8276	18	9072	76
1174	113	2037	92	5207	72	5386	85	7054	7	7201	50	8126	39	8277	18	9073	76
1178	107	2038	92	5208	72	5900	70	7055	7	7202	50	8128	38	8288	18	9075	70
1179	106	2039	92	5209	72	5901	70	7057	43	7203	50	8129	38	8289	21	9076	76
1180	70	2040	92	5210	72	5902	70	7058	43	7204	50	8130	38	8290	21	9077	76
1181	113	2041	92	5211	72	5903	70	7059	43	7205	50	8131	39	8291	21	9095	106
1182	14	3002															

Windsor

ARCHITECTURAL **HARDWARE**



windsorhardware.co.nz

Windsor Architectural Hardware Ltd
New Zealand

PO Box 1595, 42-48 Arena Avenue
Invercargill, 9840

T 0800 607 028
E sales@windsorhardware.co.nz
W windsorhardware.co.nz

Australia

T 1800 841 643
ABN 12 430 739 940
E sales@windsorhardware.com.au
W windsorhardware.com.au

*Printed using environmentally friendly inks and paper
from sustainably managed forests.*

*Products and specifications are subject to change
without notice.*